



2020
INDOOR/OUTDOOR
ATHLETIC EQUIPMENT



DESIGNED TO PERFORM. MANUFACTURED TO LAST.

Save with Jaypro Sports Equipment Packages



**StackMaster™
Base Package**

PAGE 76



**Glass Conversion
Package**

PAGE 90



**Field Hockey Goal
Package**

PAGE 53



**Portable FieldPro™
Net System Package**

PAGE 132



**NOVA™ Premiere
Adjustable Goal
Package**

PAGE 24



**Lacrosse Goal
Packages**

PAGE 54



**Soccer Goal
Packages**

PAGES 20-21



**Volleyball
System Packages**

PAGES 2-3



**GymGlide™
Packages**

PAGE 122



Disk Package

PAGE 39



Unbreakable Backboard Package

PAGE 90



Football Training Package

PAGE 52



Football Equipment Storage Package

PAGE 50



Volleyball Training Package

PAGE 17

Volleyball 2-19

Indoor & Outdoor Systems, Floor Sleeves, Nets, Referee Stands, & Training Equipment

Soccer 20-43

Goals, Indoor/Outdoor, Youth, Futsal, Nets, Rebounders, Anchors, & Combo Goals

Football 44-52

Goal Posts, Post Pads, Equipment Carts, Training Aids, Field, & Turf Accessories

Field Hockey/Lacrosse 53-57

Official Goals, Practice Goals, Training Aids, & Nets

Baseball/Softball 58-81

Batting Cages & Tunnels, Pitching Screens, Bases, Field Mats & Covers, Mounds, & Foul Poles

Field Marking 82-83

Dry, Wet & Combo Markers, Line Layout, & Marking Systems

Basketball 84-98

Outdoor Units, Hoop Rejuvenator, Post Padding, Backboards, Goals, & Edge Padding

Sports Training/Scoreboards 99-101

Sports Training Machines, & Scoreboards

Indoor Gymnasium 102-120

Portables, Wall-Mounted Backstops, Safety Straps, Winches, Height Adjusters, Curtains, Wall Pads, & Custom Graphics

Physical Education 121-127

Backboard Adapters, Game Standards, P.E. Equipment, & Bike Racks

Ball Storage 128-131

Ball Carriers, & Carts

Field Netting 132-134

Portable Netting, Ball Stop Systems, & Perimeter Netting Systems

Track & Field 135-139

Discus Cage, Pole Vault & High Jump Standards, Hurdles, & Landing Systems

Tennis 140-143

Tennis & Pickleball Posts, Nets, Benches, & Wind Screens

Benches & Bleachers/Index 144-153

Player Benches, Scorers Tables, Standard or Preferred Bleachers & Quick Index

CATALOG ICONS

COLOR CHOICES FROM CHARTS
Colors displayed may not be an exact match.



NEW PRODUCT



TRUCK FREIGHT
Product ships by truck.



BEST SELLER



USA MANUFACTURED



POWERLite™

Volleyball System Package

- Powerlite™ Volleyball System (PVB-6500 or PVB-7000)
 - Folding Referee Stand (VRS-6000)
 - Referee Stand Padding (VRS-60P)
 - Hammock Drill Cart (HSVBC24)
 - Cable/Buckle Covers (VCC-12)
- Specify pad color when ordering.*



PVB-7PKG	3½" System	\$4,495 PKG	212 lbs
PVB-6PKG	3" System	\$4,595 PKG	213 lbs



POWERLite™

Deluxe Volleyball System Package

- Powerlite™ Volleyball System (PVB-6500 or PVB-7000)
 - Folding Referee Stand (VRS-6000)
 - Referee Stand Padding (VRS-60P)
 - Hammock Drill Cart (HSVBC24)
 - Cable/Buckle Covers (VCC-12)
 - Standard Volleyball Equipment Carrier (EC-500)
 - Custom Volleyball Net Tape (CVNT-1)
 - Multi-Color Lettering and Logo (JSG-VPP)
- Specify pad color when ordering.*



PVB-7PKGDX	3½" System	\$4,995 PKG	253 lbs
PVB-6PKGDX	3" System	\$5,095 PKG	254 lbs



FEATHERLite™

Volleyball System Package

- Featherlite™ Volleyball System (PVB-4500 or PVB-5000)
 - Folding Referee Stand (VRS-6000)
 - Referee Stand Padding (VRS-60P)
 - Hammock Drill Cart (HSVBC24)
 - Cable/Buckle Covers (VCC-12)
- Specify pad color when ordering.*



PVB-5PKG	3½" System	\$4,195 PKG	199 lbs
PVB-4PKG	3" System	\$4,295 PKG	203 lbs



FEATHERLite™

Deluxe Volleyball System Package

- Featherlite™ Volleyball System (PVB-4500 or PVB-5000)
 - Folding Referee Stand (VRS-6000)
 - Referee Stand Padding (VRS-60P)
 - Hammock Drill Cart (HSVBC24)
 - Cable/Buckle Covers (VCC-12)
 - Standard Volleyball Equipment Carrier (EC-500)
 - Custom Volleyball Net Tape (CVNT-1)
 - Multi-Color Lettering and Logo (JSG-VPP)
- Specify pad color when ordering.*



PVB-5PKGDX	3½" System	\$4,595 PKG	240 lbs
PVB-4PKGDX	3" System	\$4,695 PKG	244 lbs

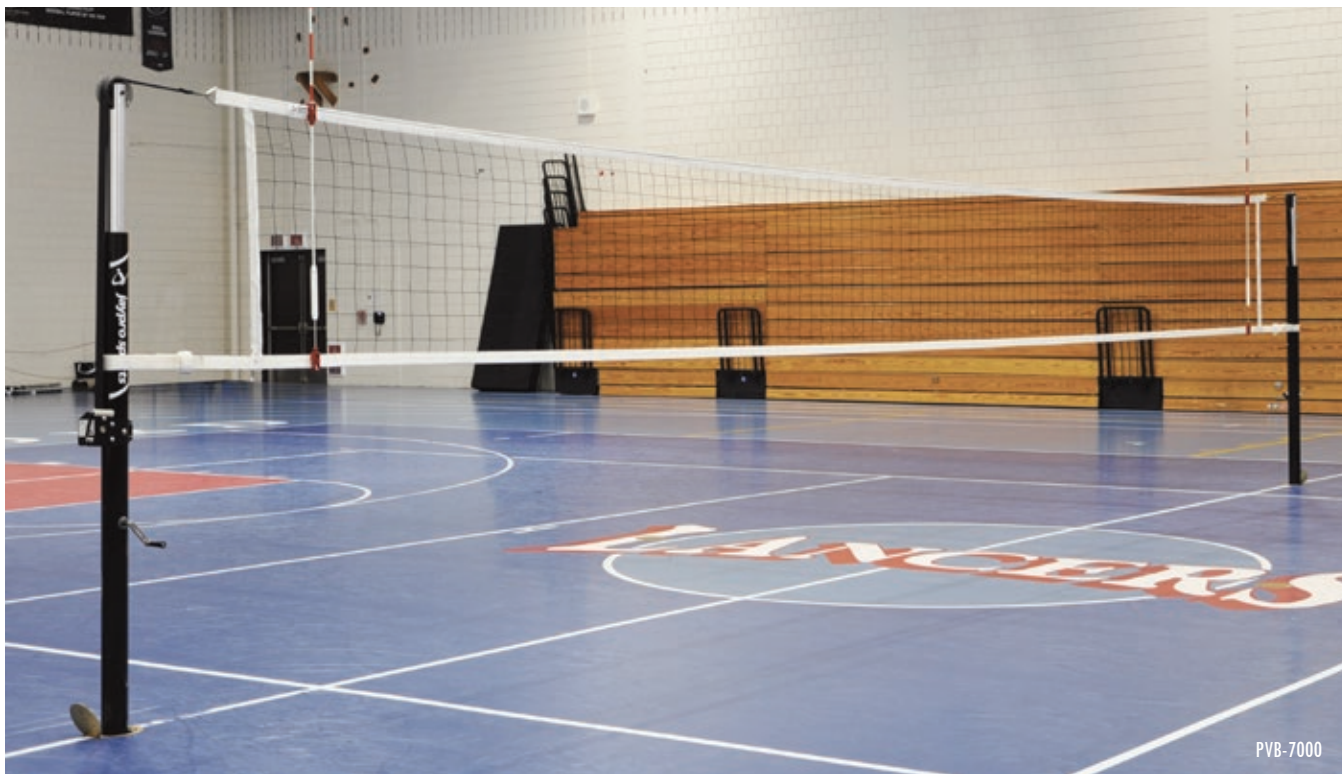

PVB-7000

POWERLite™



Powerlite™ Volleyball Systems

Infinitely adjustable volleyball systems for international, collegiate, and advanced high school level play.

- Aluminum uprights with engraved height markers (see photo below)
- Infinite height adjustment range from 6'6" to 8'2"
- Recessed polymer pulley wheels and worm drive winch
- Available in 3" and 3½" models
- Flex Net™ (PVBN-6), antennas (VBA-80), and upright padding (PVB-60P) included with complete system

Specify pad color when ordering.



* Limited Warranties



* Uprights: 10 Year Limited Warranty, Antennas, Net & Padding:
1 Year Limited Warranty

Item #	3"	Weight	Price
PVB-6500	3" Complete System	117 lbs	\$3,895 SYS
PVB-65U	3" Uprights Only	89 lbs	\$2,865 PR
<i>Includes winch. Net, antennas, and upright padding sold separately.</i>			
PVBC-650	3" Center Package	63 lbs	\$3,044 PKG
<i>Includes center pole, winch, Flex Net™, and upright padding. Purchase this in addition to complete system for a two court setup.</i>			

Item #	3½"	Weight	Price
PVB-7000	3½" Complete System	131 lbs	\$3,795 SYS
PVB-70U	3½" Uprights Only	85 lbs	\$2,850 PR
<i>Includes winch. Net, antennas, and upright padding sold separately.</i>			
PVBC-700	3½" Center Package	62 lbs	\$2,740 PKG
<i>Includes center pole, winch, Flex Net™, and upright padding. Purchase this in addition to complete system for a two court setup.</i>			

Complete System

Uprights with Winch



Flex Net™



Upright Padding

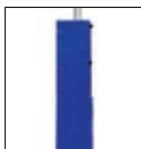

Antenna



System Features

Infinite Height Adjustment



Recessed Pulley Wheel



Worm Drive Winch

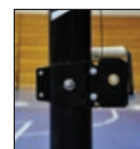

Engraved Height Markings



PAD COLORS





FEATHERLite™



Featherlite™ Volleyball Systems

Adjustable volleyball systems for collegiate and high school level play.

- Aluminum uprights with engraved height markers (see photo below)
- 16 pin-stop height adjustment range from 6'6" to 8'2"
- Recessed polymer pulley wheels and worm drive winch
- Available in 3", 3½", and 2" (Canadian) models
- Flex Net™ (PVBN-6), antennas (VBA-80), and upright padding (PVB-60P) included with complete system

Specify pad color when ordering.



* Limited Warranties



* Uprights: 10 Year Limited Warranty, Antennas, Net & Padding:
1 Year Limited Warranty

Complete System

Uprights with Winch



Flex Net™



Upright Padding

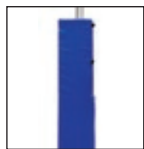

Antenna



System Features

Pin-Stop Adjustment



Recessed Pulley Wheel



Worm Drive Winch

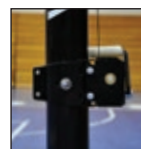

Engraved Height Markings



PAD COLORS



Item #	3"	Weight	Price
PVB-4500	3" Complete System	115 lbs	\$3,395 SYS
PVB-45U	3" Uprights Only	77 lbs	\$2,200 PR
<i>Includes winch. Net, antennas, and upright padding sold separately.</i>			
PVBC-450	3" Center Package	56 lbs	\$2,235 PKG
<i>Includes center pole, winch, Flex Net™, and upright padding. Purchase this in addition to complete system for a two court setup.</i>			

Item #	3½"	Weight	Price
PVB-5000	3½" Complete System	115 lbs	\$3,295 SYS
PVB-51U	3½" Uprights Only	73 lbs	\$2,100 PR
<i>Includes winch. Net, antennas, and upright padding sold separately.</i>			
PVBC-500	3½" Center Package	73 lbs	\$2,000 PKG
<i>Includes center pole, winch, Flex Net™, and upright padding. Purchase this in addition to complete system for a two court setup.</i>			

Item #	2" Canadian	Weight	Price
PVB-5500	2" Complete System	109 lbs	\$3,265 SYS
PVB-55U	2" Uprights Only	89 lbs	\$2,100 PR
<i>Includes winch. Net, antennas, and upright padding sold separately.</i>			



PVB-8000

Carbon Volleyball Systems

Significantly lightweight volleyball systems with the rigidity of steel. Fabricated from state-of-the-art carbon composite material!

- Adjustable range from 6'6" to 8'2"
- Adjustable feet with up to 3" of fine tuning
- Recessed polymer pulley wheels and worm drive winch
- Available in 3" and 3½" models
- Premium Net (PVBN-5), antennas (VBA-4), and upright padding (PVB-60P) included with complete system

Specify pad color when ordering.



* Limited Warranties



* Uprights: 3 Year Limited Warranty, Antennas, Net and Padding:
1 Year Limited Warranty

LADYPRO CARBON™

Carbon uprights are fixed women's height (7'4¼").

Item #	3"	Weight	Price
PVB-8500	3" Complete System	77 lbs	\$4,450 SYS
PVB-85U	3" Uprights Only	43 lbs	\$3,550 PR
<i>Includes winch. Net, antennas, and upright padding sold separately.</i>			
PVBC-850	3" Center Package	68 lbs	\$4,284 PKG
<i>Includes center pole, winch, net, and upright padding. Purchase this in addition to complete system for a two court setup.</i>			

Item #	3½"	Weight	Price
PVB-8000	3½" Complete System	77 lbs	\$4,450 SYS
PVB-80U	3½" Uprights Only	43 lbs	\$3,500 PR
<i>Includes winch. Net, antennas, and upright padding sold separately.</i>			
PVBC-800	3½" Center Package	68 lbs	\$4,284 PKG
<i>Includes center pole, winch, net, and upright padding. Purchase this in addition to complete system for a two court setup.</i>			

CARBON ULTRALITE™

Telescoping carbon uprights (intramurals to men's competition).

Item #	3"	Weight	Price
PVB-9500	3" Complete System	81 lbs	\$4,450 SYS
PVB-95U	3" Uprights Only	38 lbs	\$3,800 PR
<i>Includes winch. Net, antennas, and upright padding sold separately.</i>			
PVBC-950	3" Center Package	68 lbs	\$3,404 PKG
<i>Includes center pole, winch, net, and upright padding. Purchase this in addition to complete system for a two court setup.</i>			

Item #	3½"	Weight	Price
PVB-9000	3½" Complete System	77 lbs	\$4,450 SYS
PVB-90U	3½" Uprights Only	50 lbs	\$3,700 PR
<i>Includes winch. Net, antennas, and upright padding sold separately.</i>			
PVBC-900	3½" Center Package	68 lbs	\$3,404 PKG
<i>Includes center pole, winch, net, and upright padding. Purchase this in addition to complete system for a two court setup.</i>			

Competition Badminton Uprights

Durable uprights designed for high school, intramural and recreational competition level play. Official height!

- 2¾" x 61" steel uprights with fixed net height
- Badminton net and floor sleeves/covers sold separately

* Limited Warranties



BSO-2U	Badminton Uprights	\$633 PR	47 lbs
BND-1	Badminton Net	\$62 EA	7 lbs
BSO-2G	Floor Sleeve & Brass Cover	\$388 PR	23 lbs
BSO-2G-CP	Floor Sleeve & Chrome Cover	\$397 PR	23 lbs

* System and Floor Sleeves: 3 Year Limited Warranty,
Net: 1 Year Limited Warranty

Volleyball Post Transporter

Post transporter provides an easy solution for moving volleyball uprights in and out of storage.

- Two wheels with bearings
- Flat leveling plate
- Fits 3" and 3½" uprights

3 Year Limited Warranty

VBT \$90 EA 5 lbs



PAD COLORS



PVB-1500

* Uprights: 5 Year Limited Warranty, Antennas, Net and Padding: 1 Year Limited Warranty

Hybrid Steel Net Systems

Designed for all levels of play. Steel bottom for strength and aluminum top for lightness!

- Uprights with engraved height markers
- 16 pin-stop height adjustment range from 6'6" to 8'2"
- Recessed pulley wheels and worm drive winch
- Available in 3" (red) and 3½" (black) models
- Complete system, uprights only, and center packages
- Flex Net™ (PVBN-6), antennas (VBA-80), and upright padding (PVB-60P) included with complete system

Specify pad color when ordering.



* Limited Warranties



Item #	3"	Weight	Price
PVB-3000	3" Complete System	177 lbs	\$2,900 SYS
PVB-30U	3" Uprights Only	123 lbs	\$1,765 PR
<i>Includes winch. Net, antennas, and upright padding sold separately.</i>			
PVBC-300	3" Center Package	93 lbs	\$1,750 PKG
<i>Includes center pole, winch, Flex Net™, and upright padding. Purchase this in addition to complete system for a two court setup.</i>			

Item #	3½"	Weight	Price
PVB-1500	3½" Complete System	164 lbs	\$2,930 SYS
PVB-150U	3½" Uprights Only	118 lbs	\$1,800 PR
<i>Includes winch. Net, antennas, and upright padding sold separately.</i>			
PVBC-150	3½" Center Package	89 lbs	\$1,695 PKG
<i>Includes center pole, winch, Flex Net™, and upright padding. Purchase this in addition to complete system for a two court setup.</i>			

	Weight	3½"	Price
Complete System	128 lbs	PVB-1350	\$2,360 SYS
Uprights Only	83 lbs	PVB-13U	\$1,635 PR
<i>Includes winch. Net, antennas, and upright padding sold separately.</i>			
Center Package	62 lbs	PVBC-130	\$1,600 PKG
<i>Includes center pole, winch, net, and upright padding. Purchase this in addition to complete system for a two court setup.</i>			



	Weight	3"	Price
Complete System	128 lbs	PVB-1300	\$2,360 SYS
Uprights Only	95 lbs	PVB-1300U	\$1,635 PR
<i>Includes winch. Net, antennas, and upright padding sold separately.</i>			

Canadian Size	Weight	2"	Price
Complete System	128 lbs	PVB-1250	\$2,360 SYS
Uprights Only	89 lbs	PVB-12U	\$1,635 PR
<i>Includes winch. Net, antennas, and upright padding sold separately.</i>			

Multi-Purpose Net System

Lightweight adjustable net system for high school, intramural, and recreational play.

- Anodized aluminum uprights with infinite height adjustment sliding collars
- Available in 3½", 3" and 2" (Canadian) models
- Adjustable for badminton (BND-1 net), tennis (TPV-13 net) and volleyball (PVBN-3 net)
- Net (PVBN-3), antennas (VBA-80), worm drive winch, and upright padding (PVB-60P) included with complete system

Specify pad color when ordering.

* Limited Warranties



* Uprights: 10 Year Limited Warranty, Antennas, Net and Padding: 1 Year Limited Warranty



Second Floor Competition Net Systems

Adjustable systems designed for collegiate and high school level play. For use where floor sleeves are impractical. Top level performance without cables or wires.

- 3½" aluminum uprights with bases
- Infinite height adjustment and pin-stop height adjustment models
- 16 pin-stop height adjustment model has range from 6'6" to 8'2"

- Hand knobs secure steel T-base to in-floor anchors (sold separately)
- Flex Net™ (PVBN-6), upright/base padding (PVB-60P & PVB-25P), antennas (VBA-80), and worm drive winch included

Specify pad color when ordering.



* Limited Warranties



	Weight	Infinite	Price	Weight	Pin Stop	Price
Complete System	208 lbs	PVB-2700	\$4,000 SYS	192 lbs	PVB-2500	\$3,750 SYS
Uprights and Bases	155 lbs	PVB-270UB	\$3,170 PR	145 lbs	PVB-250UB	\$2,200 PR
<i>Includes winch, Net, antennas, and upright padding sold separately.</i>						
Center Package	114 lbs	PVBC-270	\$3,344 PKG	109 lbs	PVBC-250	\$2,316 PKG
<i>Includes center pole, winch, Flex Net™, and upright padding. Purchase this in addition to complete system for a two court setup.</i>						

* Uprights: 3 Year Limited Warranty, Antennas, Net and Padding: 1 Year Limited Warranty

PAD COLORS



Replacement Base Pad

Standard base pad designed for Second Floor Competition Net Systems (PVB-2700 and PVB-2500). Specify base pad color when ordering.

1 Year Limited Warranty **PVB-25P** \$360 PR 11 lbs

← Base Pad



Cable/Buckle Cover

- 12" long white vinyl covered foam
- Hook-and-loop attachment

1 Year Limited Warranty **VCC-12** \$83 PR 4 lbs

See page 118 for our line of Keyclean products for a clean gym floor



Universal Antennas

- 72" long alternating red/white stripes
- Clamps directly to top and bottom of net
- Fits 36" and 39" nets

1 Year Limited Warranty **VBA-80** \$168 PR 2 lbs



Antennas

- Slides into hook-and-loop attached sleeves
- Fits 36" and 39" nets

1 Year Limited Warranty **VBA-4** \$160 PR 4 lbs



Boundary Tape

- 2" tape with hook-and-loop closure
- Fits 36" and 39" nets

1 Year Limited Warranty **VA-22** \$33 PR 1 lb



Save on external storage and set-up time with a Ceiling Suspended Volleyball System by Jaypro Sports. This system stores fully assembled and close to the ceiling, is raised and lowered using a 1 HP winch, and is offered with or without an attached referee stand. Additionally, the net height is infinitely adjustable to meet both men's and women's regulation heights.



Ceiling Suspended Volleyball System

Adjustable ceiling suspended system conveniently raises and lowers with a turn-key solution for quick set-up.

- Engraved height markers (0-20" range)
- Net height adjustment handles on uprights
- Exposed posts and frames are fully padded
- With or without referee stand models
- Collegiate net and antennas included

* Call Customer Service for details

System raises to fold in either direction. Specify fold direction when ordering. Dual Posilok™ safety straps automatically lock system in position should a malfunction occur during raising or lowering of unit. Call for freight quote.



* Limited Warranties



PVBOH-880R	System with Referee Stand	Call for Pricing
PVBOH-800	System without Referee Stand	Call for Pricing

FLEXNET™

Flex Net™

Heavy-duty nylon banded net eliminates use of cumbersome cables. Designed for international, collegiate, and high school competition play!

- For uprights set between 35' and 37' (alternate sizes available)
- Headband attaches directly to winch leader strap for superb net tension
- Adjustable straps attach to existing bottom band for additional length

Due to varying court sizes, the net body may not match all court widths.



NCAA
COMPLIANT

NFHS
COMPLIANT

USVBA
COMPLIANT



1 Year Limited Warranty

Item #	For Uprights set between	Net Size	4' Strap Included	Weight	Price
Flex Net™					
PVBN-6	35' - 37'	32'L x 39"H	No	14 lbs	\$497 EA
Alternate Flex Net™ Sizes					
PVBN-628	30' - 32'	28'L x 39"H	No	13 lbs	\$497 EA
PVBN-628ADJ	32' - 35'	28'L x 39"H	Yes	11 lbs	\$545 EA
PVBN-6ADJ	37' - 40'	32'L x 39"H	Yes	14 lbs	\$545 EA

Flex Net™ (with Adapter Cord)

- Adapter cord connects existing winch and anchor upright to top of Flex Net™
- ¼" dia. anchor cord and clips included

Compatible with most manufacturer's systems such as Porter, Senoh, Bison, MacGregor, Stackhouse, Schelde, or other similar volleyball systems. Anchor cord should be cut to length in the field to adapt to the specific volleyball system.

1 Year Limited Warranty

PVBN-6AK \$565 EA 14 lbs

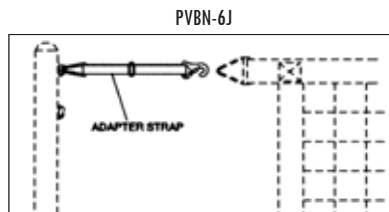
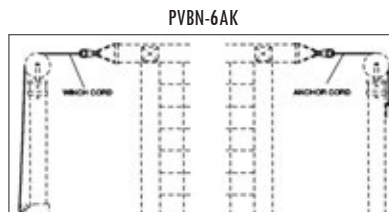

Flex Net™ (with Adapter Strap)

- 2" wide adapter strap bridges anchor upright to top of Flex Net™

Compatible with Schelde or other similar volleyball systems.

1 Year Limited Warranty

PVBN-6J \$565 EA 13 lbs

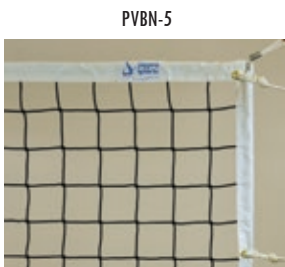

PVBN-5

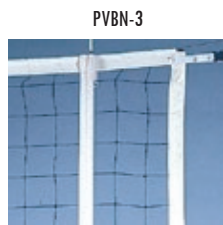

PVBN-3



VBD-3

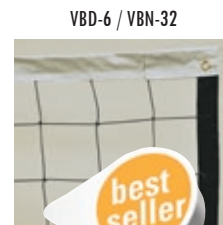

VBD-6 / VBN-32



NNI-NET-W

Premium Net

- 3.5mm knotless poly net
- Plateana top cord
- 32'L x 39"H

1 Year Limited Warranty

PVBN-5 \$300 EA 12 lbs

Item #	Type	Size	Description	Weight	Price
PVBN-3	Collegiate Net	32'L x 39"H	#21 nylon net w/coated steel cable	10 lbs	\$254 EA
VBD-3	Volleyball Net	32'L x 36"H	2.5mm poly net w/coated steel cable	7 lbs	\$87 EA
VBD-6	Volleyball Net	32'L x 36"H	2.5mm poly net w/rope cable	4 lbs	\$85 EA
VBN-32	Volleyball Net	32'L x 36"H	Nylon net w/rope cable	4 lbs	\$102 EA
NNI-NET-W	Neat Net	32'L x 36"H	2.5mm black knotless nylon	6 lbs	\$111 EA

Nets: 1 Year Limited Warranty



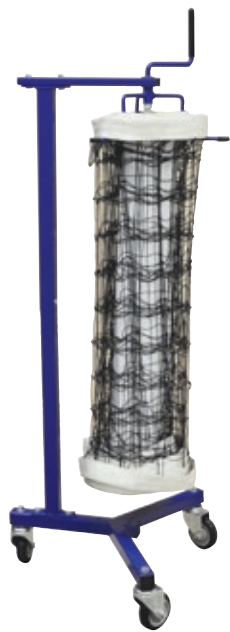

Single Net Keeper

- 1½" thick-walled steel design
- Powder coat finish
- Headband is wound clean and tangle free
- Non-marking swivel wheels
- 1 storage bag included

3 Year Limited Warranty

VNK11 \$244 EA 28 lbs



Double Net Keeper

- 1½" thick-walled steel design
- Powder coat finish
- Headband is wound clean and tangle free
- Non-marking swivel wheels
- 2 storage bags included

3 Year Limited Warranty

VNK22 \$280 EA 33 lbs

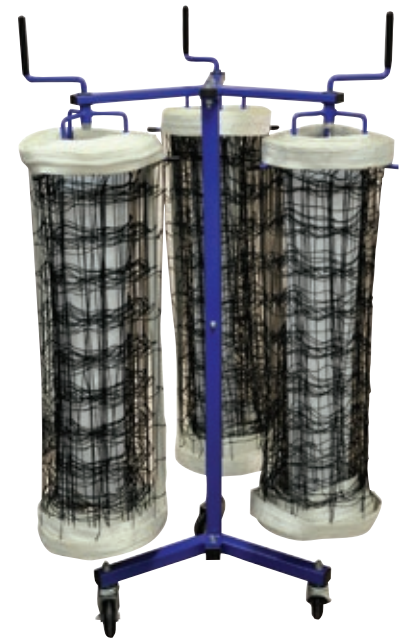

Triple Net Keeper

- 1½" thick-walled steel design
- Powder coat finish
- Headband is wound clean and tangle free
- Non-marking swivel wheels
- 3 storage bags included

3 Year Limited Warranty

VNK33 \$320 EA 37 lbs

Net Keeper Storage Bag

Replacement storage bag keeps nets, cords, and cables off the floor and protected.

1 Year Limited Warranty

VNKBAG \$36 EA 1 lb

Custom Volleyball Net Tape

Customize volleyball nets with multi-color graphics. Fits most net sizes. Contact customer service for artwork requirements. Extended lead time may apply.

1 Year Limited Warranty



CVNT-1 Top Net Tape \$444 EA 3 lbs
CVNT-2 Side Net Tape \$159 PR 2 lbs



ORDER MORE AND SAVE!

2 2 Top Net Tapes
 \$394 EA
SAVE \$50 EA

3 3 Top Net Tapes
 \$344 EA
SAVE \$100 EA

4 4 Top Net Tapes
 \$294 EA
SAVE \$150 EA

5 5 or more Top Net Tapes
 Call for Custom Quote



Shown with optional padding

“MEGA REF” Folding Referee Stand

Fold for compact storage and easy transport!

- 1 $\frac{5}{8}$ " heavy-walled steel frame with welded supports
- Vinyl padded platform and no-slip foot treads
- 4 non-marking wheels and rubber leg tips included
- Optional padding (VRS-60P) sold separately
- Folds Down - 30"W x 84"H x 10"D

300 lbs. maximum user weight.

3 Year Limited Warranty

VRS-8000 \$940 EA 78 lbs



Shown with optional padding

Folding Referee Stand

Durable referee stand folds for compact storage and easy transport.

- 1 $\frac{5}{16}$ " strong steel design
- Vinyl padded platform (48" above floor)
- 2 non-marking wheels and rubber leg tips included
- Optional padding (VRS-60P) sold separately
- Folds Down - 30"W x 84"H x 10"D

250 lbs. maximum user weight.

3 Year Limited Warranty

VRS-6000 \$655 EA 62 lbs



Shown with optional padding



Shown with optional padding

Adjustable Referee Stand

Durable two leg design referee stand clamps onto most telescoping pole systems. Adjustable feet for tweaking height!

- 1 $\frac{5}{16}$ " strong steel design with vinyl padded platform
- 2 non-marking wheels and rubber leg tips included
- Optional padding (VRS-30P) sold separately

Does not fit Multi-Purpose Net System (PVB-1350) or Outdoor Competition Volleyball System (OCV-900).

225 lbs. maximum user weight.

3 Year Limited Warranty

VRS-3000 \$745 EA 55 lbs

Stand clamps to volleyball pole



Shown with optional side banners



Beach Volleyball Referee Stand

Durable steel referee stand with all welded frame support and no-slip foot treads. Front base plate prevents stand from sinking. Transports across sand easily!

- 1 $\frac{5}{8}$ " heavy-walled design with silver textured powder coat finish
- Padded platform (48" above sand)
- 2 heavy-duty 10" dia. x 3 $\frac{1}{2}$ "W molded wheels
- Optional padding (VRS-60P) and custom side banners (CVNT-3) sold separately
- Folds Down - 30"W x 84"H x 10"D

300 lbs. maximum user weight.

* Limited Warranties

OBVRS-8	Stand	\$1,071 EA	98 lbs
CVNT-3	Custom Side Banners	\$177 PR	3 lbs



* Referee Stand: 3 Year Limited Warranty, Banners: 1 Year Limited Warranty

Official Upright Pads

- Meets competitive play specifications and fits all volleyball system uprights
 - 6"H x 2" thick foam wrapped in 14 oz. vinyl
 - Hook-and-loop closure flaps
 - Custom graphics sold separately
- Specify pad color when ordering.*

1 Year Limited Warranty

PVB-60P \$555 PR 20 lbs

See page 122 for our GymGlide™ Game Standard System that also can be fit with these pads.



PAD COLORS



Referee Stand Padding

- Meets competitive play specifications
 - 1" thick foam wrapped in 14 oz. vinyl
- Specify pad color when ordering.*

1 Year Limited Warranty

For VRS-8000, 6000 & OBVRS-8

VRS-60P \$365 EA 9 lbs

For VRS-3000

VRS-30P \$350 EA 6 lbs

VRS-30P

Custom Graphics for Upright Pads

Customize upright pads with single or multi-color lettering and graphics.

JSG-VPP \$222 PAD
Multi-color custom lettering with graphic



Contact customer service for artwork requirements and pricing.



EC-500
Standard Model

best seller



EC-1000
Deluxe Model

Volleyball Equipment Carrier

Heavy-duty welded steel carrier stores volleyballs, uprights, nets, pads, and other equipment. Protective powder coat finish!

- Non-marking swivel wheels
- Standard, deluxe, and vertical models
- Deluxe and vertical models include vinyl storage bag

3 Year Limited Warranty

EC-500 42"L x 32"W - (4 poles) \$450 EA 38 lbs

EC-1000 48"L x 36"W - (6 poles) \$660 EA 79 lbs

VEC-1 60"L x 35"W - (6 poles) \$422 EA 98 lbs



VEC-1
Vertical Model



Chrome Finish



Brass Finish



Standard
PVB-711, PVB-75CVR-CP

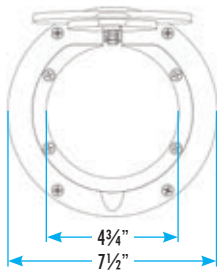

Over-sized
PVB-85CVR

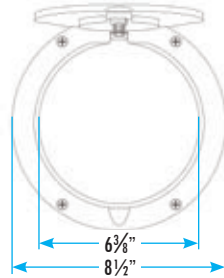

Floor Sleeves and Covers

- Heavy-duty cast brass or chrome finish design
- 7 1/2" or 8 1/2" outside dia. lockable hinged cover plates
- Spring loaded latch prevents basketball dead spots
- Available in 3 1/2", 3", and 2 3/8" models (10" deep)

3 Year Limited Warranty

Cover Plates & Sleeves

PVB-75S	Brass Cover & Sleeve	3 1/2"	\$485 PR	14 lbs
PVB-75S-CP	Chrome Cover & Sleeve	3 1/2"	\$508 PR	15 lbs
PVB-70S	Brass Cover & Sleeve	3"	\$465 PR	22 lbs
PVB-70S-CP	Chrome Cover & Sleeve	3"	\$496 PR	22 lbs
BSO-2G	Brass Cover & Sleeve	2 3/8"	\$388 PR	23 lbs
BSO-2G-CP	Chrome Cover & Sleeve	2 3/8"	\$397 PR	23 lbs

Cover Plates

PVB-711	Brass Cover	7 1/2"	\$230 EA	6 lbs
PVB-75CVR-CP	Chrome Cover	7 1/2"	\$245 EA	7 lbs
PVB-85CVR	Brass Cover	8 1/2"	\$245 EA	7 lbs

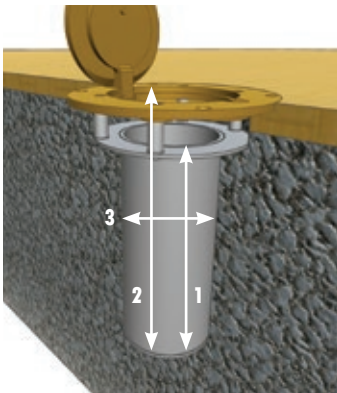

Sleeve Insert Measurement

To ensure proper fit of sleeve inserts, provide the following dimensions of sleeves when ordering.

1. Depth of sleeve itself
2. Depth from bottom of sleeve to playing surface
3. Inside diameter of sleeve (do not measure cover plate)

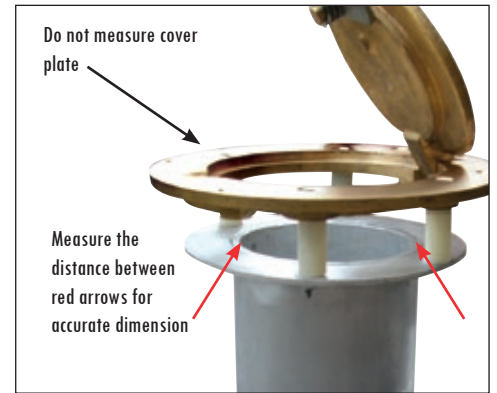

Sleeve Insert/Adapter

- Makes larger floor sleeve holes smaller

Call customer service before ordering.

3 Year Limited Warranty



PVB-DEP	Depth Reducer		\$93 EA	6 lbs
SVL-3238	Modifies 3" ID to 2 3/8" ID		\$85 EA	12 lbs
PVB-ID	Modifies 3 1/2" ID to 3" ID		\$85 EA	8 lbs
SVL-3528	Modifies 3 1/2" ID to 2 3/8" ID		\$91 EA	14 lbs
SVL-37835	Modifies 3 3/8" ID to 3 1/2" ID		\$74 EA	9 lbs
SVL-4035	Modifies 4" ID to 3 1/2" ID		\$77 EA	9 lbs

Inside Diameter (ID)

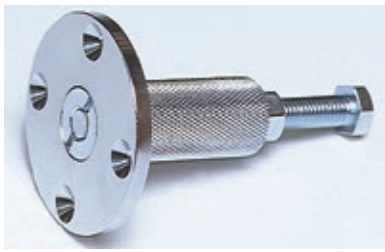

Floor Anchor (1 1/4" Cylinder)

For systems with "T" style or round bases that anchor to floor.

- 3/4" chrome cover with 1/4" wide cylinder
- Billet steel body gives 9000 lb. pullout strength
- 1/2" center - 13 thread with spring loaded closure plug
- Includes removable cylinder in case stripping occurs

Designed for all floor applications except floating wood floors. May be used without extension bolt on wood, tile, or synthetic surfaces applied directly over concrete slab or on a floating wood floor for light-duty performance.

3 Year Limited Warranty

FP-89 \$160 EA 3 lbs



Floor Anchor (1 1/4" Cylinder)

For systems with "T" style or round bases that anchor to floor.

- 1/4" wide cylinder
- Billet steel body gives 9000 lb. pullout strength
- 1/2" center - 13 thread with spring loaded closure plug
- Includes removable cylinder in case stripping occurs

Designed for all floor applications except floating wood floors. May be used without extension bolt on wood, tile, or synthetic surfaces applied directly over concrete slab or on a floating wood floor for light-duty performance.

3 Year Limited Warranty

FP-90 \$130 EA 3 lbs



Floating Wood Floor Anchor (1 1/4" Cylinder)

Brass cover plate and anchor work independently to allow for installation into floating wood floors.

- 3/4" brass cover with 1/4" wide cylinder
- Billet steel body gives 9000 lb. pullout strength
- 1/2" center - 13 thread with spring loaded closure plug
- Includes removable cylinder in case stripping occurs

3 Year Limited Warranty

FP-100 \$170 EA 4 lbs

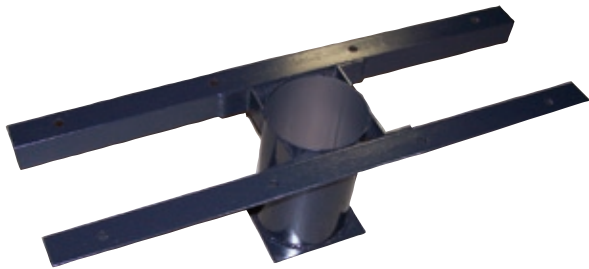

Second Floor Sleeve Bracket

Designed for second story installation of floor sleeves or where there is less than 12" clearance in the sub-floor. Mounting hardware included. Custom designs available.

3 Year Limited Warranty

SB-10 \$351 EA 32 lbs



Wall Rack

- Holds 3 volleyball posts in upright position
- Heavy-duty steel storage rack attaches to wall

3 Year Limited Warranty

VBWR-1 \$235 EA 7 lbs

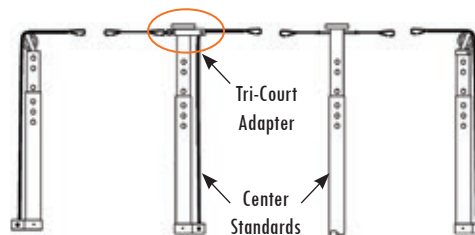

Volleyball System Tri-Court Adapter

Converts two center standards into a third court. Compatible with many Jaypro Sports volleyball systems!

- Attaches onto existing center standards
- Improves tension out of middle net

3 Year Limited Warranty

PVB-303CAK PVB-3000 System \$160 EA 6 lbs

PVB-35TCA PVB-7000, 6500, 5000, 4500 and 1500 Systems \$164 EA 6 lbs



Hammock Drill Cart

Durable steel frame is collapsible for easy storage with a low profile making it easier to turn, reach and spike.

- Holds up to 24 balls
- Nylon carry bag with shoulder strap included
- 48"L x 22"W x 40"H x 12"D

3 Year Limited Warranty

HSVBC24

\$142 EA 15 lbs

See pages 128-131 for our line of Ball Storage Carts and Carriers



ToteMaster™ Open Top

- Holds up to 33 volleyballs, nets, pads, and other equipment
- 4" x 3" wire mesh open top storage baskets
- Deeper upper basket for larger items
- 48"L x 26"W x 54"H

3 Year Limited Warranty

TE-PE01

\$260 EA 46 lbs



Premium Ball Carrier

See page 131 for product details.



Deluxe Ball Carriers

Highly durable carriers with non-marking swivel wheels.

- 1" all welded steel frame
- 15 Volleyball Carrier - 39"L x 22"W x 36"H
- 21 Volleyball Carrier - 60"L x 22"W x 36"H

15 Volleyball Carrier

BBC-12RB Royal Blue \$134 EA 26 lbs

BBC-12BK Black \$134 EA 26 lbs

BBC-12RD Red \$134 EA 26 lbs



21 Volleyball Carrier

BBC-18RB Royal Blue \$150 EA 41 lbs

BBC-18BK Black \$150 EA 41 lbs

BBC-18RD Red \$150 EA 41 lbs

5 Year Limited Warranty

System Replacement Parts

3 Year Limited Warranty

Worm Drive Winch

- 1½" leader strap & handle included

PVBWINCH \$424 EA 7 lbs

Cargo Buckle Winch

HM5044 \$94 EA 3 lbs

Leader Strap (for HM5044)

PVB101A \$67 EA 2 lbs

Leader Strap (for PVBWINCH)

PVB603 1½" wide \$77 EA 3 lbs

Winch Handle (for PVBWINCH purchased after 2008)

VBW-HANDLE-08 \$79 EA 1 lb

Handle

- For telescoping height adjustment and old blue style winch

PVB607I \$44 EA 1 lb

Pin Chain Assembly (1500/5000/4500)

PVB512 \$19 EA 2 lbs



PVBWINCH



HM5044



PVB101A



PVB603



VBW-HANDLE-08



PVB607I



PVB512

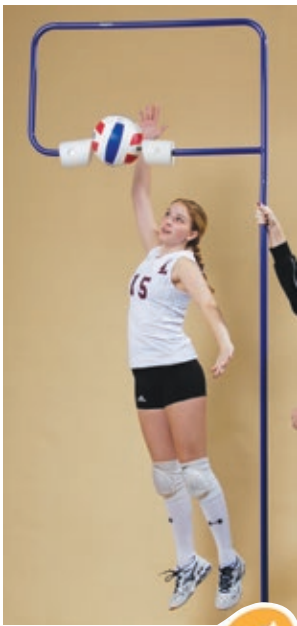

The Spiker

Develop spiking/serving skills.

- 6' to 12' aluminum telescoping pole with foam ball holder
- Polyethylene base included

3 Year Limited Warranty

TS612 \$267 EA 5 lbs



The Jumper

Measure jump reach.

- Color coded spring pegs in 1" increments
- 6' to 12' aluminum telescoping pole
- Polyethylene base included

3 Year Limited Warranty

TJ612 \$222 EA 10 lbs



The Attacker

Practice game-like blocking situations.

- Adjustable 1' x 1½' foam blocking surfaces
- Polyethylene base included

3 Year Limited Warranty

TA115 \$333 EA 10 lbs



The Blocker

Practice defending blocked spikes.

- Adjustable aluminum pole (up to 11')
- 2' x 3' foam blocking surface
- Polyethylene base included

3 Year Limited Warranty

TB11 \$322 EA 7 lbs



Volleyball Training Package

Everything needed for developing key volleyball skills.

- The Spiker (TS612)
- The Jumper (TJ612)
- The Attacker (TA115)
- The Blocker (TB11)

3 Year Limited Warranty

VTAPACK \$810 PKG 49 lbs



Attack Volleyball Machine

Designed for men's games. Maximize daily practice drills with accurate and repeatable reps.

See page 99 for details about this product. Call for freight quote.

VBSA-1



Attack II Volleyball Machine

Designed for women's games. Maximize daily practice drills with accurate and repeatable reps.

See page 99 for details about this product. Call for freight quote.

VBSA-2



Skill Attack Volleyball Machine

Designed for club and youth programs. Maximize daily practice drills with accurate and repeatable reps.

See page 99 for details about this product. Call for freight quote.

VBSA-3



Coastal Competition Volleyball System

Heavy-duty system designed to withstand coastal winds and weather.

Adjustable winch for play at any height!

- 4" square heavy-walled aluminum uprights with additional inside lateral support
- Ground sleeves, installation tool, winch, and weather resistant net included

* Limited Warranties



OCC-500	System	\$1,395	SYS	195 lbs
OCC-500N	Replacement Net	\$199	EA	9 lbs

* Uprights: 3 Year Limited Warranty, Net: 1 Year Limited Warranty

Inside lateral support



OCC-500N



Outdoor Competition Volleyball System

Durable system designed for outdoor competition. Fixed net heights for men's and women's play!

- 3½" galvanized steel uprights with silver powder coat finish
- Quickly attach net with snap buckles
- Available in system and center package models
- 36" ground sleeves, cover caps, and rust-resistant ratchet included
- Net (PVBN-3) recommended and sold separately. Net upgrades (PVBN-5 and OBVN-2) also sold separately.

3 Year Limited Warranty



OCV-900	System	\$1,130	SYS	140 lbs
OCV-900C	Center Package	\$699	EA	125 lbs



Recreational Outdoor Volleyball Uprights

Ideal for volleyball, badminton, or tennis.

- 2¾" galvanized steel uprights
- PVC ground sleeves, top caps, and rust-resistant ratchet winch included
- Net (VBD-3) recommended and sold separately

Ground sleeves are designed to be set even with playing surface. Contact Jaypro Sports for special installation requirements.

3 Year Limited Warranty



OS-350		\$599	SYS	80 lbs
---------------	--	-------	-----	--------



Adjustable Volleyball Court Line

- 2" wide black webbed boundary line
- Adjusts from 30' x 60' to FIVB regulation (8m x 16m)
- 8" corner stakes with bungee cord and plastic reel included

1 Year Limited Warranty

AVCL-2		\$60	EA	2 lbs
---------------	--	------	----	-------

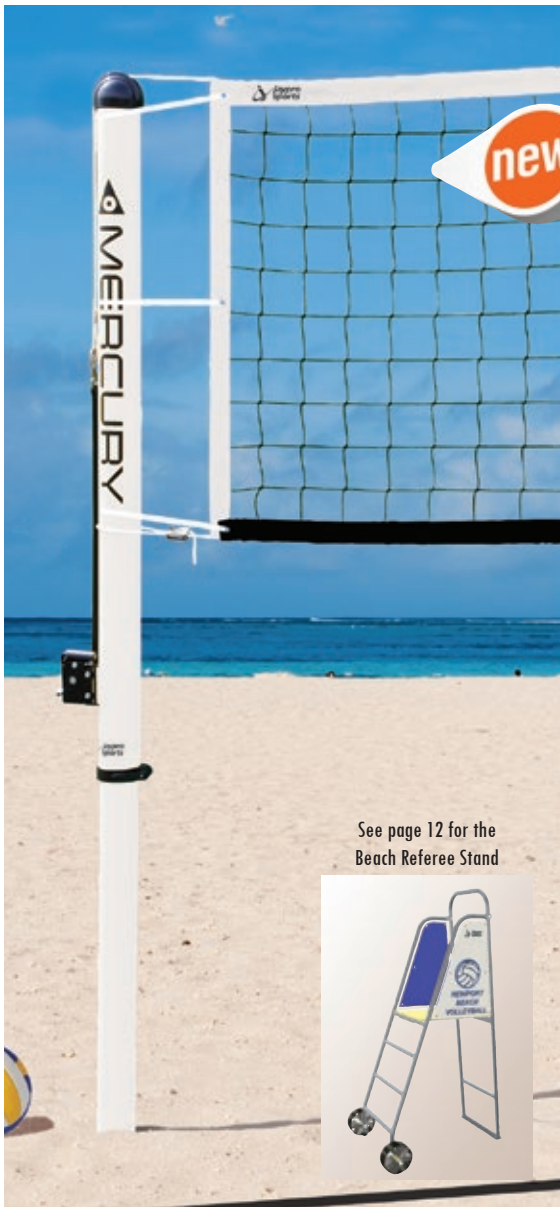

See page 12 for the Beach Referee Stand



Mercury™ Beach Volleyball System

Adjustable beach system with inverted telescoping design and carbon reinforced caps to prevent sand and water infiltration.

- Lightweight aluminum design with white powder coat finish
- Adjustable height between 5'6" and 7'11 1/8"
- 3 1/2" bottom poles compatible with any 3 1/2" ID sleeves (OBV-100AK recommended and sold separately)
- Mercury™ net (competition or recreation size), antenna, and upright padding included

Specify upright padding color and preferred net when ordering.



* Limited Warranties

* Uprights and Antennas: 3 Year Limited Warranty, Net and Padding: 1 Year Limited Warranty

	Weight	3 1/2"	Price
Complete System <i>Includes official net.</i>	78 lbs	OBV100-OFF	\$3,299 SYS
Complete System <i>Includes recreational net.</i>	78 lbs	OBV100-REC	\$3,299 SYS
Uprights Only <i>Includes winch.</i>	75 lbs	OBV100U	\$2,250 PR
Ground Inserts <i>Includes caps & safety flag.</i>	15 lbs	OBV-100AK	\$475 PR

Top Cap



Quik-Collar



Ground Insert



PAD COLORS



Mercury™ Beach Volleyball Net

- 3" vinyl border and headband with 4" #36 black netting
- 1/4" top Plateena cord with swaged loop on one end
- 1/4" double braided polyester bottom rope
- Dowels and polyester straps with buckles included
- Custom headband (CVNT-1) and side net tapes (CVNT-2) sold separately

1 Year Limited Warranty

OBVN-1	Official Competition Net 28'L x 39"H	\$459 EA	12 lbs
OBVN-2	Recreational Size Net 32'L x 39"H	\$459 EA	12 lbs



Double Play Sand Rake

See page 81 for product details.

1 Year Limited Warranty

DPR-36 \$90 EA 6 lbs



Sand Rake

See page 81 for product details.

1 Year Limited Warranty

FR-36 \$80 EA 5 lbs



NOVA™ Premiere Goal Package (White)

- 2 NOVA™ Premiere Goals (SGP-600)
- (2) 5mm, 5½" hex mesh white nets (SN-HTTP-W)
- 4 World Cup™ Anchors - 1 Set (SGA-50)
- 1 NOVA™ Goal Wheel Kit (NSGWK)

* Limited Warranties



SGP-600PKGWHI

\$5,845 PKG 598 lbs



NOVA™ Premiere Goal Package (Black/White)

- 2 NOVA™ Premiere Goals (SGP-600)
- (2) 5mm, 5½" hex mesh two-tone black/white nets (SN-2BLKW)
- 4 World Cup™ Anchors - 1 Set (SGA-50)
- 1 NOVA™ Goal Wheel Kit (NSGWK)

* Limited Warranties



SGP-600PKGBLK

\$5,845 PKG 598 lbs



NOVA™ Premiere Goal Package (Blue/White)

- 2 NOVA™ Premiere Goals (SGP-600)
- (2) 5mm, 5½" hex mesh two-tone blue/white nets (SN-2BLUW)
- 4 World Cup™ Anchors - 1 Set (SGA-50)
- 1 NOVA™ Goal Wheel Kit (NSGWK)

* Limited Warranties



SGP-600PKGBLU

\$5,845 PKG 598 lbs



In-ground anchors or appropriate amount of counterweight required per goal. See page 34 for ASTM counterweight requirements for your specific goal.

* Goal: 12 Year Lifetime Warranty, Anchors and Wheel Kit: 3 Year Limited Warranty, Net: 1 Year Limited Warranty

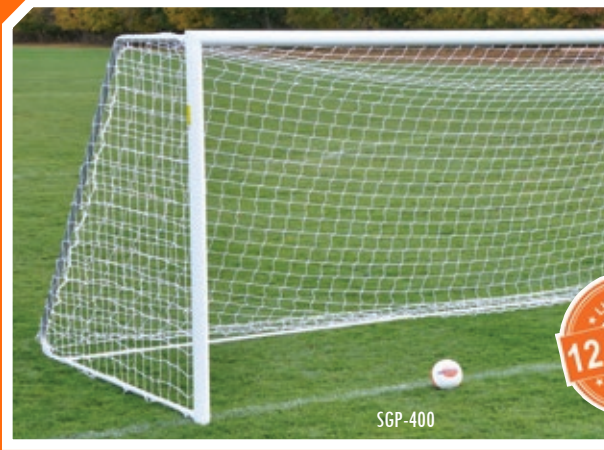

SGP-400



SGP-760

Classic Official Round or Square Goal Package

- 2 Classic Round Official Goals (SGP-400) or 2 Classic Square Official Goals (SGP-760)
- (2) 4mm, 5½" sq. mesh white nets (SND-8)
- 4 Auger Anchors - 1 Set (SAS-95)
- 1 Classic Wheel Kit (CSGWK)



* Limited Warranties



SGP-400PKG	Round Goal	\$3,780 PKG	534 lbs
SGP-760PKG	Square Goal	\$3,780 PKG	557 lbs



SGP-400



SGP-760

Deluxe Classic Official Round or Square Goal Package

- 2 Classic Round Official Goals (SGP-400) or 2 Classic Square Official Goals (SGP-760)
- (2) 4mm, 5½" sq. mesh white nets (SND-8)
- 4 World Cup™ Anchors - 1 Set (SGA-50)
- 1 Classic Wheel Kit (CSGWK)



* Limited Warranties



SGP-400PKGDX	Round Goal	\$4,000 PKG	538 lbs
SGP-760PKGDX	Square Goal	\$4,000 PKG	558 lbs



In-ground anchors or appropriate amount of counterweight required per goal. See page 34 for ASTM counterweight requirements for your specific goal.

* Goal: 12 Year Lifetime Warranty, Anchors and Wheel Kit: 3 Year Limited Warranty, Net: 1 Year Limited Warranty

NOVA™

SOCCER

Dealer Rated BEST In Customer Service ★★★★★

JAYPRO.COM 800-243-0533

22



SGP-850 shown with optional wheel kits

Features Jaypro Sports flush mount

EASY TRACK™
Net Attachment System



Tension Cable



Upright Brace



Corner Fitting for Net Stay Pole



ASTM Compliant



NOVA™ World Cup Goal

Features Jaypro Sports flush mount Easy Track™ net attachment system with clips.

- Official size with white powder coat finish
- All aluminum extruded goal
- 4" extruded aluminum goal face with 2" x 4" base frame
- White 2 3/8" steel back net posts (color options available for additional charge - call for details)
- Optional wheel kit (NSGWK) sold separately
- Stainless steel hardware included
- Ground anchors, counterweights and nets (SGP-850N) sold separately
- 24'W x 8'H x 7'B x 8'D

NCAA
COMPLIANT

NFHS
COMPLIANT

FIFA
COMPLIANT

12 Year Lifetime Warranty



SGP-850

\$6,900 PR

450 lbs

In-ground anchors or appropriate amount of counterweight required per goal. See page 34 for ASTM counterweight requirements for your specific goal.



NOVA™ World Fold-Up Goal

Features Jaypro Sports flush mount Easy Track™ net attachment system with clips.

- Official size international style aluminum goal with white powder coat finish
- Field maintenance friendly with fold-up rear frame can be temporarily pinned or permanently locked in raised position
- 4" extruded aluminum with a 2" x 4" base frame
- 2³/₈" galvanized steel back posts
- Ground sleeves for semi-permanent installation included
- World competition hex net and stainless steel hardware included
- 24'W x 8'H x 6'B x 6'D



12 Year Lifetime Warranty



SGP-660

\$5,290 PR 534 lbs



NOVA™ World Classic Goal

Same as NOVA™ World Fold-Up Goal (SGP-660) except without fold-up rear frame.

- 24'W x 8'H x 6'B x 6'D



12 Year Lifetime Warranty



SGP-550

\$3,755 PR 432 lbs



Features Jaypro Sports flush mount

EASY TRACK™
Net Attachment System

FieldPro™ Soccer Ball Stop System

Stop wasting time chasing missed shots or errant passes during practice and games. Ensure the safety of athletes, coaches, and spectators.

- Designed to fit behind soccer goals
- (4) 4" heavy-walled aluminum uprights with ground sleeves and covers
- #36 knotted black nylon net with 3¹/₂" sq. mesh and 1/4" rope border
- Pulley system to raise/lower net included
- Corrosion-resistant hardware included
- 20'H x 65'L

Custom sizes available. See page 132-134 for more FieldPro™ Net System options.

* Limited Warranties



FNSB-65

\$2,390 EA 250 lbs

* System: 3 Year Limited Warranty, Net: 1 Year Limited Warranty





NOVA™ Premiere Goal Packages
See page 20 for package details.



Features Jaypro Sports flush mount
EASY TRACK™
Net Attachment System



Backstays



Cast Corners



ASTM Compliant



NOVA™ Premiere Goal

Features Jaypro Sports flush mount Easy Track™ net attachment system with clips.

- Official size with white powder coat finish
- International style all aluminum goal
- 4" extruded aluminum with a 2" x 4" base frame
- 1.7" aluminum European and auxiliary backstays
- Optional wheel kit (NSGWK) sold separately
- Stainless steel hardware included

- Ground anchors, counterweights, and nets sold separately
- 24'W x 8'H x 4'B x 10'D



12 Year Lifetime Warranty



SGP-600

\$5,200 PR

446 lbs

In-ground anchors or appropriate amount of counterweight required per goal. See page 34 for ASTM counterweight requirements for your specific goal.



NOVA™ Premiere Adjustable Goal Package

- 2 NOVA™ Premiere Adjustable Goals (SGP-600AX)
- (2) 5mm, 5½" hex mesh two-tone blue/white nets (SN-2BLUW)
- 4 World Cup™ Anchors - 1 Set (SGA-50)
- 2 NOVA™ Goal Wheel Kits (NSGWK)

* Limited Warranties



SGP-600AXPKG

\$6,410 PKG

651 lbs



* Goal: 12 Year Lifetime Warranty, Anchors and Wheel Kit: 3 Year Limited Warranty, Net: 1 Year Limited Warranty



Features Jaypro Sports flush mount
EASY TRACK™
Net Attachment System



Adjustable Crossbar



Backstays



ASTM Compliant



NOVA™ Premiere Adjustable Goal

Same as NOVA™ Premiere Goal (SGP-600) except with:

- Infinitely adjustable rear crossbar allows goal to fit under any football goal post
- No fixed settings and no fixed depth on crossbar (bottom bar adjusts from 4' to 8' deep)
- Anchor kits available for football goal post (SFGA-6, SFGA-5 or SFGA-4)

- Optional wheel kit (NSGWK) sold separately
- Stainless steel hardware included
- Ground anchors, counterweights, and nets sold separately
- 24'W x 8'H x 4'B x 10'D

12 Year Lifetime Warranty



SGP-600AX

\$5,380 PR 513 lbs

In-ground anchors or appropriate amount of counterweight required per goal. See page 34 for ASTM counterweight requirements for your specific goal.



Soccer/Football Anchor Kit

- Fastens the soccer goal rear crossbar to a football goal gooseneck

3 Year Limited Warranty



SFGA-6	6 ⁵ / ₈ " OD Gooseneck	\$145 KIT	10 lbs
SFGA-5	5 ¹ / ₁₆ " OD Gooseneck	\$157 KIT	10 lbs
SFGA-4	4 ¹ / ₂ " OD Gooseneck	\$168 KIT	10 lbs



IMPROVED



NOVA™ Wheel Kit

Attaches to any NOVA™ goal base (SGP-600 and NOVA™ club round and square).

- (4) 10" no-flat wheels
- Kit equips 2 goals

3 Year Limited Warranty



NSGWK \$499 KIT 49 lbs



SGP-400 Round



Classic Goal Packages
See page 21 for package details.

SGP-760 Square

Classic Official Goals



Features Jaypro Sports flush mount Easy Track™ net attachment system with clips.

* Limited Warranties



- Official size with white powder coat finish
- 4" round or square extruded aluminum frame with 2" galvanized steel backstays and rear crossbar
- Portable and semi-permanent models
- Wheel kit (CSGWK), ground anchors, counterweights, and net sold separately
- 24'W x 8'H x 4'B x 10'D



Classic Official Round Goal

SGP-400	Portable Goal	\$3,060 PR	478 lbs
SGP-440	Semi-Permanent Goal with Galvanized Steel Backstays	\$2,895 PR	384 lbs
SGP-440EB	Semi-Permanent Goal with European Backstays	\$3,020 PR	306 lbs
SGP-445G	Ground Sleeves for Semi-Permanent Goal (Set of 4)	\$510 SET	20 lbs

Features Jaypro Sports flush mount



Classic Official Square Goal

SGP-760	Portable Goal	\$3,065 PR	478 lbs
SGP-730	Semi-Permanent Goal with Galvanized Steel Backstays	\$3,940 PR	345 lbs
SGP-730EB	Semi-Permanent Goal with European Backstays	\$3,020 PR	241 lbs
SGP-735G	Ground Sleeves for Semi-Permanent Goal (Set of 4)	\$550 SET	18 lbs

In-ground anchors or appropriate amount of counterweight required per goal. See page 34 for ASTM counterweight requirements for your specific goal.

* Goal: 12 Year Lifetime Warranty, Sleeves: 3 Year Limited Warranty



Soccer Goal Cart

Swivel wheel goal carts allow goals to be moved in all directions with ease. Will transport any official or club soccer goal.

3 Year Limited Warranty

SGT-24	\$899 PR	72 lbs
---------------	-----------------	--------



Classic Wheel Kit



Attaches to any goal base (SGP-760, SGP-400, SGP-110 and all Classic Club Round Goals).

- (4) 10" no-flat wheels and equips 2 goals
- No drilling of backstay pipe required

3 Year Limited Warranty



CSGWK	\$429 KIT	40 lbs
--------------	------------------	--------



Team Official Square Goal

Features Jaypro Sports flush mount Easy Track™ net attachment system with clips.

- Official size with white powder coat finish
- 4" x 2" aluminum frame with 2" galvanized steel backstays and rear crossbar
- Backstays run back 10' for more stable base
- Wheel kit (CSGWK), ground anchors, counterweights, and nets sold separately
- 24'W x 8'H x 4'B x 10'D



Features Jaypro Sports flush mount

EASY TRACK™
Net Attachment System



3 Year Limited Warranty



SGP-110

\$2,570 PR 459 lbs

In-ground anchors or appropriate amount of counterweight required per goal. See page 34 for ASTM counterweight requirements for your specific goal.



Team Official Round Goal (Semi-Permanent)

Powder coated aluminum goal that features Jaypro Sports flush mount Easy Track™ net attachment system with clips. Designed without backstays for permanent/semi-permanent installation!

- Official size with white powder coat finish
- 4" crossbar and uprights
- Nets, net clips, and net pegs included
- Aluminum ground sleeves with locking caps sold separately
- 24'W x 8'H



Features Jaypro Sports flush mount

EASY TRACK™
Net Attachment System

* Limited Warranties



SGP-220

\$2,150 PR 432 lbs

SGP-445G Ground Sleeves (Set of 4)

\$510 SET 20 lbs

* Goal, Clips and Pegs: 3 Year Limited Warranty, Net: 1 Year Limited Warranty



EASY TRACK™
Net Attachment System



Auger Anchors



Upright Brace



Cast Corners



NOVA™ Club Round Goals

Features Jaypro Sports flush mount Easy Track™ net attachment system with clips. White powder coat finish!

- 3" extruded aluminum frames with European and auxiliary backstays
- Multiple sizes available
- 4" sq. mesh white nets (SCN-24), net clips, augers, and stainless steel hardware included
- Wheel kit (NSGWK) sold separately



Item	Weight	Counter Weight	Size	Price
RCG-24S	402 lbs	150 lbs	24'W x 8'H x 4'B x 9'D	\$3,859 SET
RCG-21S	378 lbs	170 lbs	21'W x 7'H x 3'B x 8'D	\$3,599 SET
RCG-18S	316 lbs	240 lbs	18½'W x 6½'H x 2'B x 6'D	\$3,399 SET
RCG-12S	306 lbs	240 lbs	12'W x 6½'H x 2'B x 6'D	\$3,259 SET
RCG-9S	218 lbs	*	9'W x 4½'H x 2'B x 5'D	\$2,599 SET
RCG-6S	198 lbs	*	6'W x 4'H x 2'B x 5'D	\$2,299 SET

* Limited Warranties



In-ground anchors or appropriate amount of counterweight required per goal. See page 34 for ASTM counterweight requirements for your specific goal.

* Goal: 12 Year Lifetime Warranty, Net: 1 Year Limited Warranty

Which size goal does your program need?

See page 34 for recommended goal size for your age group and number of players



NOVA™ Wheel Kit

IMPROVED

Attaches to any NOVA™ goal base (SGP-600 and NOVA™ club round and square).

- (4) 10" no-flat wheels
- Quick and easy wheel engagement
- Kit equips 2 goals

3 Year Limited Warranty



NSGWK

\$499 KIT

49 lbs





EASY TRACK
Net Attachment System



Auger Anchors



Cast Corners



Backstays



Classic Club Round Goal

Features Jaypro Sports flush mount Easy Track™ net attachment system with clips. White powder coat and natural finish design!

- 3" extruded aluminum front frames with galvanized steel backstays
- Multiple sizes available (galvanized steel rear crossbars on three largest sizes)
- 4" sq. mesh white nets (SCN-24), net clips, and augers included
- Wheel kit (CSGWK) sold separately



Item	Weight	Counter Weight	Size	Price
CC24S	481 lbs	140 lbs	24'W x 8'H x 4'B x 9'D	\$2,669 SET
CC21S	412 lbs	160 lbs	21'W 7'H x x 3'B x 8'D	\$2,499 SET
CC18S	361 lbs	240 lbs	18½'W x 6½'H x 2'B x 6'D	\$2,299 SET
CC12S	305 lbs	240 lbs	12'W x 6½'H x 2'B x 6'D	\$2,099 SET
CC9S	157 lbs	*	9'W x 4½'H x 2'B x 5'D	\$1,697 SET
CC6S	136 lbs	*	6'W x 4'H x 2'B x 5'D	\$1,597 SET

* Limited Warranties



In-ground anchors or appropriate amount of counterweight required per goal. See page 34 for ASTM counterweight requirements for your specific goal.

* Goal: 12 Year Lifetime Warranty, Net: 1 Year Limited Warranty

Which size goal does your program need?

See page 34 for recommended goal size for your age group and number of players



Classic Wheel Kit

Attaches to any goal base (SGP-760, SGP-400, SGP-110 and all Classic Club Round Goals).

- (4) 10" no-flat wheels
- No drilling of backstay pipe required
- Quick and easy wheel engagement
- Kit equips 2 goals



3 Year Limited Warranty



CSGWK

\$429 KIT

40 lbs

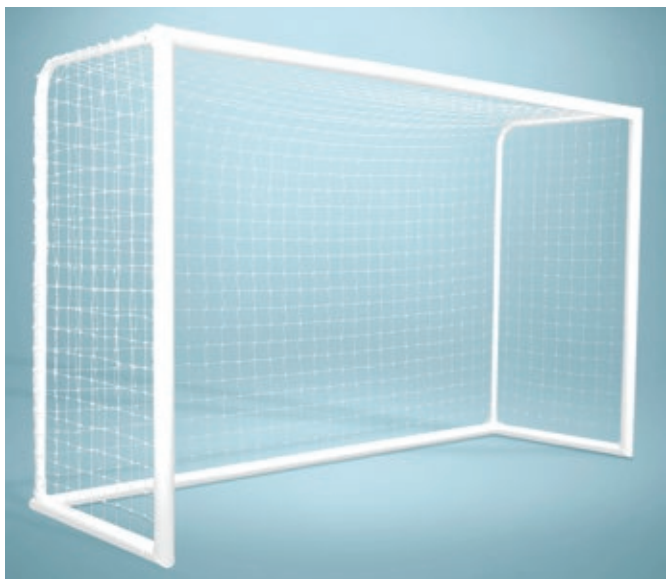

Deluxe Official Futsal Goal

Features Jaypro Sports flush mount Easy Track™ net attachment system with clips.

- 1 official size goal with white powder coat finish
- 3" round aluminum goal face and base with extruded channel
- 1¼" round heavy-walled aluminum backstays
- Polyethylene white net with 4" sq. mesh (FSG67910N)
- Stainless steel hardware included
- Optional NOVA™ Wheel Kit (NSGWK) sold separately
- 9'10"W x 6'7"H x 3'3"D

* Limited Warranties



FSG-1 \$1,648 EA 240 lbs

* Goal: 3 Year Limited Warranty, Net: 1 Year Limited Warranty



Official Futsal Goal

Features Jaypro Sports flush mount Easy Track™ net attachment system with clips.

- 1 portable goal with white powder coat finish
- Extruded aluminum frame
- Official size 9'10"W (3m) x 6'7"H (2m) meets specifications
- (1) 4" sq. mesh net
- Non-marring floor protectors included

* Limited Warranties



FSG-2	Goal	\$1,400 EA	101 lbs
FSG67910NHP	Replacement Net	\$100 EA	5 lbs
FSGWK	Wheel Kit	\$499 KIT	40 lbs

* Goal and Wheel Kit: 3 Year Limited Warranty, Net: 1 Year Limited Warranty



Practice Futsal Goal

- 1 official size goal with white powder coat finish
- Folds for portability and storage
- 1.9" heavy-duty steel galvanized pipe goal face
- 1½" OD steel galvanized pipe backstays
- 4" sq. mesh net held in place with hook-and-loop closure strips
- Non-marring floor protectors
- 9'10"W x 6'7"H x 3'3"D

* Limited Warranties



FPG-23	Goal	\$750 EA	63 lbs
FPG-23N	Replacement Net	\$88 EA	41 lbs

* Goal: 3 Year Limited Warranty, Net: 1 Year Limited Warranty



Indoor/Outdoor Folding Goal

For competitive indoor play and as an outdoor training/youth goal.

- Indoor/outdoor use
- 2" zinc undercoated steel frame powder coated white
- 1 5/16" backstays fold without removing net
- 4" sq. mesh net
- Non-marring floor protectors included
- 12'W x 7'H x 4'D

See pages 34-35 for ground anchors for outdoor use.

* Limited Warranties



SFG-14HP	Goal	\$405 EA	81 lbs
SFG-14NHP	Replacement Net	\$99 EA	4 lbs

* Goal: 3 Year Limited Warranty, Net: 1 Year Limited Warranty



Hook-and-loop net straps eliminate lacing.



Portable Short-Sided Soccer Goals

- 1 5/16" galvanized steel frame powder coated white
- All-welded side frames and rear ground crossbars for increased strength and durability
- Snap pins lock frame in place for added safety
- Folds for easy transport and storage
- 2.5mm twisted net with 4" sq. mesh
- Ground anchors and net ties included
- Optional Floor Protection Kit (PSS-4FT) sold separately to use indoors

* Limited Warranties

For 4 vs 4 Play:

PSS-612	12'W x 6'H x 31"D Goal	\$315 EA	51 lbs
PSS-612N	Replacement Net	\$52 EA	3 lbs
PSS-608	8'W x 6'H x 31"D Goal	\$299 EA	44 lbs
PSS-608N	Replacement Net	\$49 EA	2 lbs
PSS-510	10'W x 5'H x 34"D Goal	\$270 EA	43 lbs
PSS-510N	Replacement Net	\$47 EA	4 lbs

For 3 vs 3 Play:

PSS-406	6'W x 4'H x 24"D Goal	\$260 EA	30 lbs
PSS-406N	Replacement Net	\$40 EA	2 lbs

* Goal: 3 Year Limited Warranty, Net: 1 Year Limited Warranty

Floor Protector Kit

Ideal for using Portable Short-Sided Soccer Goals indoors.

- Help protect gymnasium floor from being scratched or damaged
- Kit includes self-threading screws with 4 rubber feet

3 Year Limited Warranty

PSS-4FT	\$32 KIT	2 lbs
----------------	----------	-------

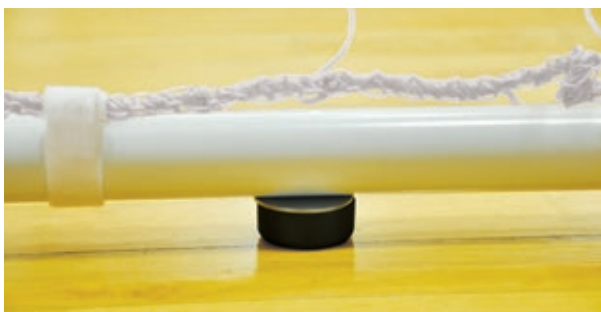

Quick Set-Up Goal

Great for any league or backyard use.

- Sets up in minutes with quick release push-pins
- 2" aluminum frame
- Goal width adjusts to 8', 16' or 24' x 8'H
- Net, 6 net pegs, indoor floor pads and carry bag included

* Limited Warranties



SEYL-824	Goal	\$799 EA	52 lbs
SEYL-24NHP	Replacement Net	\$132 EA	7 lbs

* Goal: 3 Year Limited Warranty, Net: 1 Year Limited Warranty



Rugged Play Goal

For precision shooting drills or short-sided games.

- Quick release push-pins make break down easy
- 2" galvanized steel frame
- 2.5mm orange polyethylene net with 4" sq. mesh
- Includes rubber feet to protect gymnasium floor
- 8'W x 4'H x 4'D

* Limited Warranties

SMG-8HP	Goal	\$264 EA	42 lbs
SMG-8NHP	Replacement Net	\$40 EA	5 lbs

* Goal: 3 Year Limited Warranty, Net: 1 Year Limited Warranty



Two-For-Youth Goal

- Two sizes in one (4' x 6' or flip to 3' x 6')
- Easy quick release push-pin assembly
- 1½" aluminum frame powder coated white
- 1¾" sq. black mesh net
- Hook-and-loop attachment

* Limited Warranties



MPG-46	Goal	\$295 EA	24 lbs
MPG-46N	Replacement Net	\$48 EA	2 lbs

* Goal: 3 Year Limited Warranty, Net: 1 Year Limited Warranty





Soccer Pop-Up Trainers



- Durable and safe lightweight pop-up goals
- Fiberglass rod frame w/steel spring corners and heavy-duty net
- Equipped with anchoring pegs to ensure stability
- Folds down to 1" flat oval
- Available in 2 sizes
- Zipper nylon bag with handles included

1 Year Limited Warranty

SGPU4830R	4'W x 2½'H x 2½'D (Red)	\$63 PR	11 lbs
SGPU7240B	6'W x 3'4"H x 3'4"D (Blue)	\$100 PR	11 lbs



Goal Runner™



- Indoor/outdoor youth use
- Steel frame folds flat for compact storage
- Non-marking front wheels for easy transport
- Durable knotless nylon net with vinyl sleeves
- Hook-and-loop closures (no lacing required)
- Available in 3 sizes

* Limited Warranties

STG-23	Small Goal - 3'W x 2'H	\$133 EA	20 lbs
STG-23N	Replacement Net	\$60 EA	2 lbs
STG-34	Medium Goal - 4'W x 3'H	\$185 EA	28 lbs
STG-34N	Replacement Net	\$75 EA	3 lbs
STG-46	Large Goal - 6'W x 4'H	\$240 EA	38 lbs
STG-46N	Replacement Net	\$98 EA	4 lbs

* Goal: 3 Year Limited Warranty, Net: 1 Year Limited Warranty



Adjustable Soccer Rebounder

- 3 adjustable playback angles
- 1¼" heavy-duty steel frame and support base
- White mesh net with ¼" cord
- Folds flat for easy transport and storage
- Rebound Surface - 40"W x 40"H

3 Year Limited Warranty

ASR33BK	\$285 EA	27 lbs
----------------	----------	--------

WORLD CUP™ ANCHOR

SOCCER



World Cup™ Anchor

- Tank style anchor has 4¾"W x 3¼"H opening designed to fit over any round or flat rear crossbar
- Hard plastic shell will not crack when filled in the field with 50 lbs. concrete, or 39 lbs. sand
- Built-in carry handle and stackable design for convenient storage
- Bright yellow color for visibility and safety
- 12"W x 8½"H

3 Year Limited Warranty



SGA-50	Set of 4	\$300 SET	12 lbs
SGA-51	Single	\$88 EA	3 lbs



See below for ASTM counterweight requirements for your specific goal.



Multi-Use Soccer Cart

- Heavy-duty utility cart
- Pull by hand or tow by ATV/Utility Tractor
- Fold-down sides for easy loading
- (4) 13" x 5" wide pneumatic turn wheels rated to hold up to 350 lbs.
- Holds up to 16 World Cup™ Anchors (SGA-50)
- 51"L x 26"W

3 Year Limited Warranty



SGA-CART	\$675 EA	65 lbs
-----------------	-----------------	--------

SOCCER GOAL COUNTERWEIGHT REQUIREMENTS

Visit our website for the latest information

www.Jaypro.com/ASTM

Which size goal does your program need?

Age Group	Recommended Goal Size	Maximum Ball Size	Minimum Players/Team
U-13	8' x 24'	5	11 vs 11
U-12	Up to 6½' x 18½'	4	9 vs 9
U-11	Up to 6½' x 18½'	4	9 vs 9
U-10	Up to 6½' x 18½'	4	7 vs 7
U-9	Up to 6½' x 18½'	4	7 vs 7
U-8	Up to 4' x 6'	3	4 vs 4
U-6/U-7	Up to 4' x 6'	3	4 vs 4

Jaypro Sports is committed to safety on the field. Because of this we have created the Secure 4 Safety Program which promotes soccer goal safety.



Sandbag Anchor

- Fill sandbag in the field with 50 lbs. of dry sand
- Choose from steel carry handle or nylon strap design
- Custom colors on orders of 10 or more (SWB-451 only)

3 Year Limited Warranty



SWB-451 w/ Steel Handle \$75 EA 2 lbs
SWB-454 w/ Steel Handle - Set of 4 \$290 SET 8 lbs

SWB-451W w/Nylon Handle \$56 EA 2 lbs
SWB-454W w/Nylon Handle - Set of 4 \$180 SET 6 lbs

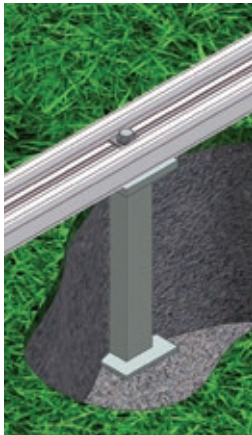

In-Ground Anchor

- Securely anchors any portable NOVA™ goal or existing goal with minor modification
- Will not pull out or slide off the base frame
- Set includes 2 anchors for one goal

3 Year Limited Warranty

SGA-60 \$230 PR 11 lbs

Counterweight Requirements

See page 34 for ASTM counterweight requirements for your specific goal.

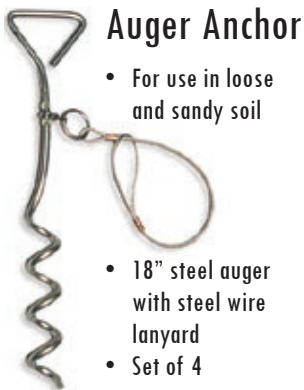

Auger Anchor

- For use in loose and sandy soil
- 18" steel auger with steel wire lanyard
- Set of 4

3 Year Limited Warranty

SAS-95 \$77 SET 5 lbs



J-Hook Stake

- For use in firm and compressed soil
- 18" durable "J" style steel stake with steel wire lanyard
- Set of 4

3 Year Limited Warranty

SGA-91 \$105 SET 16 lbs



Spike Anchor

- For use in firm and tightly compacted soil
- 18" long 3/4" galvanized steel spike with steel wire lanyard
- Set of 4

3 Year Limited Warranty

SS-18 \$117 SET 12 lbs

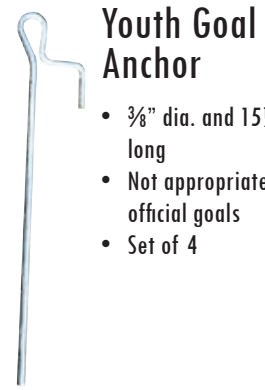

Youth Goal Anchor

- 3/8" dia. and 15 1/2" long
- Not appropriate for official goals
- Set of 4

3 Year Limited Warranty

217RP \$57 SET 2 lbs



2 Tone Hexagon

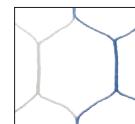

Durable Twisted & Knotted



Durable Braided & Knotted

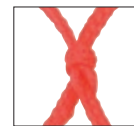

	Item #	Size	Mesh	Twine	Color	Weight	Price
OFFICIAL	SOC-6*	8' x 24' x 4' x 10'	5½" sq.	6mm Braid	WHITE	29 lbs	\$286 PR
	SND-8*	8' x 24' x 4' x 10'	5½" sq.	4mm Braid	WHITE	28 lbs	\$250 PR
	SND-7*	8' x 24' x 4' x 10'	5½" sq.	4mm Braid	ORANGE	30 lbs	\$250 PR
	SN-40B*	8' x 24' x 4' x 10'	5½" sq.	4mm Braid	BLUE	25 lbs	\$340 PR
	SN-40R*	8' x 24' x 4' x 10'	5½" sq.	4mm Braid	RED	20 lbs	\$340 PR
	SN-40Y*	8' x 24' x 4' x 10'	5½" sq.	4mm Braid	YELLOW	20 lbs	\$340 PR
	SGP-850N*	8' x 24' x 6½' x 7½'	4¾" sq.	4mm Braid	WHITE	25 lbs	\$209 PR
	SN-HTTP-W*	8' x 24' x 4' x 10'	5½" hex	5mm Braid	WHITE	29 lbs	\$374 PR
	SGP-550N*	8' x 24' x 6' x 6' Box	5½" hex	5mm Braid	WHITE	22 lbs	\$365 PR
	SN-6BLUW*	8' x 24' x 6' x 6' Box	5½" hex	5mm Braid	WHITE BLUE	25 lbs	\$340 PR
	SN-6GRNW*	8' x 24' x 6' x 6' Box	5½" hex	5mm Braid	WHITE GREEN	25 lbs	\$340 PR
	SN-6REDW*	8' x 24' x 6' x 6' Box	5½" hex	5mm Braid	WHITE RED	25 lbs	\$340 PR
	SN-6BLKW*	8' x 24' x 6' x 6' Box	5½" hex	5mm Braid	WHITE BLACK	25 lbs	\$340 PR
	SN-2BLUW*	8' x 24' x 4' x 10'	5½" hex	5mm Braid	WHITE BLUE	28 lbs	\$295 PR
	SN-2GRNW*	8' x 24' x 4' x 10'	5½" hex	5mm Braid	WHITE GREEN	28 lbs	\$295 PR
SN-2REDW*	8' x 24' x 4' x 10'	5½" hex	5mm Braid	WHITE RED	28 lbs	\$295 PR	
SN-2BLKW*	8' x 24' x 4' x 10'	5½" hex	5mm Braid	WHITE BLACK	28 lbs	\$295 PR	
CLUB	SEYL-24NHP*	8' x 24' x 0' x 8'	5½" sq.	2.5mm Twist	WHITE	7 lbs	\$132 EA
	SCN-24*	8' x 24' x 4' x 10'	4" sq.	3mm Twist	WHITE	24 lbs	\$205 PR
	SCN-21	7' x 21' x 3' x 8'	4" sq.	3mm Twist	WHITE	18 lbs	\$180 PR
	SCN-18	6½' x 18½' x 2' x 6'	4" sq.	3mm Twist	WHITE	10 lbs	\$170 PR
	SCN-12	6½' x 12' x 2' x 6'	4" sq.	3mm Twist	WHITE	10 lbs	\$145 PR
	SCN-9	4½' x 9' x 2' x 5'	4" sq.	3mm Twist	WHITE	7 lbs	\$99 PR
	SCN-6	4½' x 6' x 2' x 5'	4" sq.	3mm Twist	WHITE	6 lbs	\$89 PR
YOUTH	SFG-14NHP	7' x 12' x 1' x 4'	4" sq.	2.5mm Twist	WHITE	4 lbs	\$99 EA
	SMG-8NHP	4' x 8' x 0' x 4'	4" sq.	2.5mm Twist	ORANGE	5 lbs	\$40 EA
	PSS-612N	6' x 12' x 0' x 31"	4" sq.	2.5mm Twist	ORANGE	3 lbs	\$52 EA
	PSS-608N	6' x 8' x 0' x 31"	4" sq.	2.5mm Twist	ORANGE	2 lbs	\$49 EA
	PSS-510N	5' x 10' x 0' x 34"	4" sq.	2.5mm Twist	ORANGE	4 lbs	\$47 EA
	PSS-406N	4' x 6' x 0' x 24"	4" sq.	2.5mm Twist	ORANGE	2 lbs	\$40 EA

* Official Size Nets - Nets: 1 Year Limited Warranty

EASY TRACK™



Easy Track™ Net Clips

- Rigid plastic clips fit securely and flush into Easy Track™ net attachment system so net won't slip
- 100 clips in a bag (enough clips for a pair of goals)

3 Year Limited Warranty

EC-824	White	\$85 BAG	1 lb
EC-824PK	Pink	\$89 BAG	1 lb
EC-824BK	Black	\$89 BAG	1 lb
EC-824RD	Red	\$89 BAG	1 lb
EC-824BL	Blue	\$89 BAG	1 lb

Jaypro Sports Easy Track™ net clips are compatible with other soccer goal brands.

Hook-and-Loop Closure Strips

Convenient hook-and-loop closure strips secure net without lacing.

3 Year Limited Warranty

SINT-20	Kit of 20 - Fits up to 2" tubing	\$40 KIT	2 lbs
SINT-25	Kit of 25 - Fits up to 2" tubing	\$47 KIT	2 lbs
SINT-40	Kit of 40	\$54 KIT	2 lbs
SINT-60	Kit of 60	\$65 KIT	2 lbs

*SINT-20 fits up to (1) 12' goal. SINT-25 fits up to (1) 24' goal.
SINT-40 fits up to (2) 12' goals. SINT-60 fits up to (2) 24' goals.*



Bungees

- (30) 6" long bungees
- Two bags required for Medium Soccer Rebounder (STGRB718)
- Three bags required for the Large Soccer Rebounder (STGRB824)

3 Year Limited Warranty

STGRB718B	30 count	\$33 BAG	2 lbs
-----------	----------	----------	-------



Hook-and-Loop Closure

- Closure roll is 1½" wide x 75' long
- Enough to fit a pair of official goals

3 Year Limited Warranty

VNS-25	\$93 SET	2 lbs
--------	----------	-------



Net Clips

- Treated steel "money clip" design
- For use with existing pre-drilled 5/16" dia. holes
- 70 clips in a kit (enough for a pair of 8' x 24' goals)
- Plastic retainers included

3 Year Limited Warranty

SNT-180	\$74 KIT	2 lbs
SNT-200	\$59 KIT	2 lbs



Net Pegs

- Prevent balls from passing under net
- Set of 25

3 Year Limited Warranty

NP-25	\$47 SET	3 lbs
-------	----------	-------

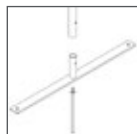

Stable Anchored Base

The powder coated white ground base assembly lies flat on the ground. The ground stake is inserted through the middle of the base to anchor it to the ground. The upright is placed over a sleeve on the base assembly, resulting in a stable goal with no visible anchor to cause a tripping hazard.

Portable Training Goal

- 2" lightweight aluminum frame with stabilizing base plates
- 4" sq. mesh nylon net and carry bag included

* Limited Warranties

STG-718	Medium - 18'W x 7½'H	\$630 EA	52 lbs
STG-718N	Medium Replacement Net	\$50 EA	4 lbs
STG-824	Large - 24'W x 8'H	\$710 EA	62 lbs
STG-824N	Large Replacement Net	\$95 EA	5 lbs

* Goal: 3 Year Limited Warranty, Net: 1 Year Limited Warranty

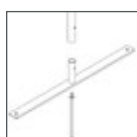

Stable Anchored Base

The powder coated white ground base assembly lies flat on the ground. The ground stake is inserted through the middle of the base to anchor it to the ground. The upright is placed over a sleeve on the base assembly, resulting in a stable goal with no visible anchor to cause a tripping hazard.

Soccer Rebounder

- 2" lightweight aluminum frame with stabilizing base plates
- 1½" sq. mesh net, bottom crossbar, and powder coat finish
- Bungee net attachments and carry bag included

* Limited Warranties

STGRB718	Medium - 18'W x 7½'H	\$796 EA	48 lbs
RB718N	Medium Rebound Net	\$99 EA	6 lbs
STGRB824	Large - 24'W x 8'H	\$940 EA	112 lbs
RB824N	Large Rebound Net	\$122 EA	9 lbs

* Rebounder: 3 Year Limited Warranty, Net: 1 Year Limited Warranty



Equipment Carry Bags

Heavy-duty black bags with reinforced zipper.

- Large - Holds the Quick-Set Up Goal (SEYL-824)
- Medium - Holds Portable Training Goal and Soccer Rebounder
- Small - Holds Two-For-Youth Goal (MPG-46) and other items

1 Year Limited Warranty

ECB-LG	Large Bag - 105" L x 15" dia.	\$94 EA	6 lbs
ECB-MD	Medium Bag - 100" L x 13" dia.	\$84 EA	3 lbs
ECB-SM	Small Bag - 78" L x 11" dia.	\$71 EA	4 lbs



Bungees

- (30) 6" long bungees
- Two bags required for Medium Soccer Rebounder (STGRB718)
- Three bags required for the Large Soccer Rebounder (STGRB824)

1 Year Limited Warranty

STGRB718B	30 count	\$33 BAG	2 lbs
------------------	----------	-----------------	-------



Corner Flags

- Official 5' tall x 1" dia. PVC poles
- Set includes 4 poles, 4 flags and 4 black rubber bases
- Indoor/outdoor

RBF-4 \$251 SET 34 lbs

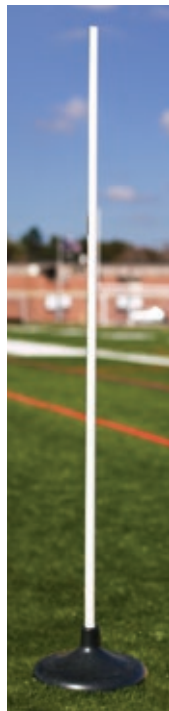

Coaching Sticks

- Official 5' tall x 1" dia. PVC poles
- Each base weighs over 7 lbs.
- 6 poles and 6 black rubber bases
- Indoor/outdoor

RBCS-6 \$299 SET 50 lbs



Corner Flag Bag

- Convenient storage bag carries up to 8 flags
- Constructed of washable black vinyl

CFCB \$73 EA 3 lbs

Training Cone

- Solid plastic stackable cone with perimeter base
- Bright orange for high visibility
- Available in 2 heights



D171 9" Cones \$2.04 EA 1 lb
D175 12" Cones \$3.54 EA 2 lbs

Flag Base Bag



- Vinyl carry bag holds 4 rubber bases
- 12"W x 12"D x 14"H

RBF-BASE \$34 EA 3 lbs

Replacement Flags

- (4) 13½" x 12" red nylon flags

RBF-FLAG \$17 SET 5 lbs

Deluxe Corner Flags

- 60" tall x ¾" thick PVC poles
- Stationary base

DCF-251 Set of 4 \$85 SET 7 lbs

Deluxe Training Flags

- 60" tall x ¾" thick PVC poles
- Flexible spring loaded base

DCF-255 Set of 4 \$94 SET 7 lbs



Disk Cone (Single)

- Highly visible and won't tip over
- 2¼" tall with a 7½" dia. base

D272BL Blue \$.94 EA 1 lb
D272OR Orange \$.94 EA 1 lb
D272RD Red \$.94 EA 1 lb
D272YW Neon Yellow \$.94 EA 1 lb



Disk Cone Carrier

- Durable white vinyl-coated 5mm steel frame
- Holds up to 200 disk cones (not included)
- 7" dia. x 12"H

DCC7 \$8 EA 1 lb



Field ID Marker

- 14" x 14" vinyl marker with corner grommets
- Specify color and numbers when ordering.*

FIM-14 \$49 EA 1 lb

Disk Cone (Set)

- Available in quantities of 100 per set

D272BL-100 Blue \$70 SET 4 lbs
D272OR-100 Orange \$70 SET 4 lbs
D272RD-100 Red \$70 SET 4 lbs
D272YW-100 Neon Yellow \$70 SET 4 lbs



Disk Package

- Disk Cone Carrier (DCC7)
- 30 Cones (D272) of blue, orange, red and neon yellow
- 120 cones in package

3 Year Limited Warranty

DCPKG \$84 PKG 9 lbs

* All Items on this page: 3 Year Limited Warranty, except Field ID Marker: 1Year Limited Warranty



NOVA™ Team Shelter

Used extensively in Europe, team shelters not only provide refuge from the elements, but the sleek look of European styling adds class to any sport facility and a boost to the morale of any program.

- Unbreakable tinted polycarbonate
- Heavy-duty extruded aluminum frame
- Available in five different widths
- 8½" pneumatic wheels only on 8', 12' and 16' widths
- 6'10" tall x 4'8" deep base
- Ground anchors included
- Natural finish anodized aluminum bench

- Add team colors to your bench at no extra cost (specify colors when ordering)
 - Call for details and pricing to add team colors or customized graphics to your shelter
- Call for freight quote.*

3 Year Limited Warranty



POWDER COAT COLORS



Item	Description	Seats	Weight	Price
NTS-8	8' Team Shelter w/Seat	5	600 lbs	\$3,371 EA
NTS-12	12' Team Shelter w/Seat	8	980 lbs	\$4,451 EA
NTS-16	16' Team Shelter w/Seat	10	1,190 lbs	\$6,256 EA
NTS-20	20' Team Shelter w/Seat	13	1,821 lbs	\$7,759 EA
NTS-24	24' Team Shelter w/Seat	16	1,915 lbs	\$9,197 EA

Bleachers • Player Benches • Enclosures



See pages 144-152 for details about Jaypro Sports player and spectator seating.



Soccer Shelter

- Powder coated steel frame with removable polyester top for quick and easy (dis)assembly
- 4 auger stakes for grass or 4 sand bags (filled in the field) for turf anchoring (specify when ordering)
- Wheel kit included
- See page 144-145 for optional player benches
- 17'W x 6'4"H x 5'D

Call for freight quote.

1 Year Limited Warranty



SCSHLT-(X) \$4,360 EA 350 lbs

Item	Color
SCSHLT-G	Gray
SCSHLT-NB	Navy Blue
SCSHLT-B	Royal Blue
SCSHLT-R	Red
SCSHLT-BK	Black
SCSHLT-M	Maroon
SCSHLT-GR	Green

Upgrade your shelter with any of the following options:

1 Year Limited Warranty



Shelter Wind Flap

- Flaps add protection from wind and rain
- 17' x 2' mesh fabric sewn into cover with wind flap added to rear of shelter

SCSHLT-WF \$716 EA

2' x 2' Team Logo

- Sewn on side panel

SCSHLT-LOG022 \$168 EA

3" Team Lettering

- Letters are sewn across front panel

SCSHLT-LTR \$133 EA

4' x 4' Team Logo

- Sewn on rear panel

SCSHLT-LOG044 \$296 EA

Vector files required for team logos. Other file formats require an art charge. Call customer service for additional options.

Referee/Scorekeeper Shelter

- Easy to move and assemble
- Powder coated steel frame
- Removable polyester cover
- Same lettering and logo options listed above are offered
- 8½' x 6½' x 4'8"

Call for freight quote.

1 Year Limited Warranty



RSHLT-(X) \$2,460 EA 350 lbs



Item	Color
RSHLT-G	Gray
RSHLT-NB	Navy Blue
RSHLT-B	Royal Blue
RSHLT-R	Red
RSHLT-BK	Black
RSHLT-M	Maroon
RSHLT-GR	Green



Features Jaypro Sports flush mount

EASY TRACK™
Net Attachment System

Deluxe Official Soccer/Football Goal

Ideal for multi-purpose athletic facilities.

- Designed for permanent or semi-permanent installation
- 4" round extruded aluminum soccer uprights and crossbars, powder coated white
- 2" removable soccer backstays
- 2 3/8" aluminum football uprights
- Nets, post padding, and ground sleeves sold separately
- Soccer Dimensions - 8' x 24' x 10' x 4'
- Football Uprights - 10' tall



3 Year Limited Warranty



FBSC-240 Goal w/Standard Backstays \$4,300 PR 500 lbs

FBSC-240EB Goal w/European Backstays \$4,885 PR 470 lbs

Aluminum Ground Sleeves

- Aluminum ground sleeves with locking caps for semi-permanent installation

3 Year Limited Warranty



SGP-445G Set of 4 \$510 SET 20 lbs



Goal

Standard Backstay

European Backstay



Ground Sleeves

- (4) 24" ground sleeves and 4 locking caps included

3 Year Limited Warranty

SGP-722G \$616 SET 18 lbs

Official Soccer/Football Goal

Ideal for shared football and soccer fields.

- Meets high school regulations for competition football and soccer
- Designed for permanent or semi-permanent installation
- Football uprights can be installed at high school (23'4") or collegiate (18'6") widths and removed for soccer play
- 2" x 4" goal support uprights made of 14 gauge steel tubing
- 2" square steel tube football uprights are 10' tall
- "Money Clip" attachments included - ground sleeves (SGP-722G) optional
- Nets and backstays sold separately
- Soccer Dimensions - 8' x 24'

3 Year Limited Warranty



Goal (without Backstays)

- Recommended Portable Combo Goal Net (SEYL-24NHP) sold separately

FBSC-120 \$3,794 PR 650 lbs

Standard Backstay Kit

- Removable soccer backstays made from 1.66" galvanized steel tubing
- Recommended standard official size net (8' x 24' x 4' x 10') sold separately

FBSC-120FBS Set of 4 \$774 SET 140 lbs

European Backstay Kit

- Removable European backstays made from 1.66" galvanized steel tubing with 4' depth
- Recommended standard official size net (8' x 24' x 4' x 10') sold separately

FBSC-120EBS Set of 4 \$774 SET 45 lbs



Portable Practice Football/Soccer Combo Goal (High School)

- Lightweight and stable
- 2" galvanized steel construction
- Double no-flat wheels for easy transport
- Available in two colors (specify when ordering)
- Net and wind streamers sold separately
- Soccer Dimensions - 8' x 24'
- Football Crossbar - 23'4" wide
- Football Uprights - 10' tall

* Limited Warranties



PCG-800 \$2,175 EA 331 lbs

PNT-1 White or Yellow Powder Coat \$168 EA
Specify when ordering.

SEYL-24NHP Replacement Net \$132 EA 7 lbs

* Goal: 3 Year Limited Warranty, Net: 1 Year Limited Warranty

Portable Practice Football Goal (High School)

- H-frame with double no-flat wheels
- 23'4"W x 20'H

3 Year Limited Warranty



PPG-4HS \$2,028 EA 375 lbs

Portable Practice Football Goal (Collegiate)

- H-frame with double no-flat wheels
- 18'6"W x 20'H

3 Year Limited Warranty



PPG-4C \$2,028 EA 375 lbs



H-Frame Football Goal Post

- Designed for permanent installation
- 4" heavy-walled aluminum tubing
- Uprights extend 10' above crossbar
- Powder coated white
- 23'4"W x 20'H

3 Year Limited Warranty



HFGP-3 \$3,208 PR 426 lbs

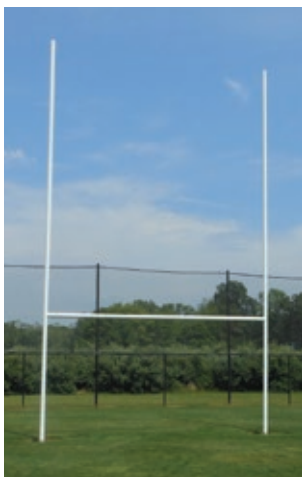

Official Rugby Goal

- Designed for permanent installation
- Official size rugby goal measures 18'4"W (5.6m) x 32'H (9.8m)
- Uprights extend 22' above crossbar and made with 4" Sch 40 aluminum tubing
- Crossbar is 4" aluminum tubing
- Tough powder coated white finish

3 Year Limited Warranty



RGP-3 Goal \$4,614 PR 580 lbs
RGP-SQP Pad \$707 EA 42 lbs

Rugby Goal Pad

Call customer service for details.

Custom lettering and graphics available. See page 120 for details.



MAX-1™

MAX-1™ Aluminum Football Goal Posts

All aluminum goal posts available in high school and collegiate official sizes.

- 6 $\frac{5}{8}$ " crossbar and gooseneck available with 6' or 8' offset
- 4" uprights available in 20' or 30' heights
- 30' uprights are two-piece (Single-piece available upon request)
- Adjustable in two directions ensures crossbar and uprights are level and plumb
- Permanent/semi-permanent or adjustable leveling plate installation
- Ground sleeves for semi-permanent installation sold separately, see page 47

Call for freight quote.

8' offset perfect for multi-purpose fields can be used with soccer goals SGP-600AX, SGP-400, SGP-760, and CC24S.

White or Pro Yellow powder coat options. Specify post color when ordering.



3 Year Limited Warranty

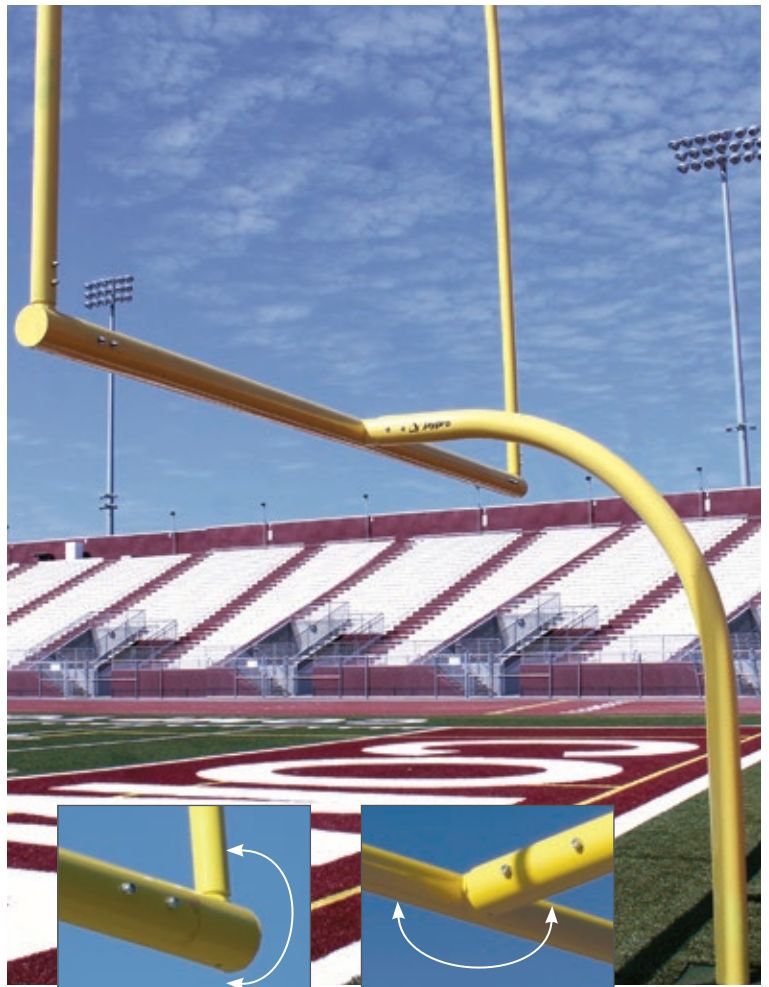

Adjustable in two directions

	Offset	Uprights	Weight	Semi-Permanent / Permanent Item #	Price	Weight	Leveling Plate Item #	Price
High School 23' 4" wide	6'	20'	920 lbs	FBGP-520XX	\$8,405 PR	920 lbs	FBGP-420XX	\$10,087 PR
	6'	30'	CALL	FBGP-530XX	\$8,877 PR	CALL	FBGP-430XX	\$10,425 PR
	8'	20'	1,086 lbs	FBGP-820XX	\$8,651 PR	940 lbs	FBGP-920XX	\$10,476 PR
	8'	30'	CALL	FBGP-830XX	\$9,123 PR	CALL	FBGP-930XX	\$10,814 PR
Collegiate 18' 6" wide	6'	20'	860 lbs	FBGP-520CXX	\$8,293 PR	900 lbs	FBGP-420CXX	\$10,231 PR
	6'	30'	CALL	FBGP-530CXX	\$8,765 PR	CALL	FBGP-430CXX	\$10,569 PR
	8'	20'	880 lbs	FBGP-820CXX	\$8,539 PR	880 lbs	FBGP-920CXX	\$10,313 PR
	8'	30'	CALL	FBGP-830CXX	\$9,011 PR	CALL	FBGP-930CXX	\$10,651 PR

MAX-1™ Expandable Crossbars

Telescoping design adjusts crossbar width for official use at 23'4" (high school) and 18'6" (collegiate). Anti-rotation feature holds uprights in place allowing adjustment by one person.

3 Year Limited Warranty

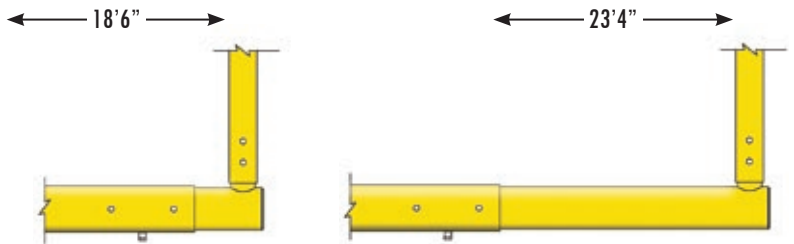

	Offset	Uprights	Weight	Semi-Permanent / Permanent Item #	Price	Weight	Leveling Plate Item #	Price
Expandable 18' 6" - 23' 4" wide	6'	20'	900 lbs	FBGP-520AXXX	\$9,751 PR	940 lbs	FBGP-420AXXX	\$11,208 PR
	8'	20'	920 lbs	FBGP-820AXXX	\$9,999 PR	960 lbs	FBGP-920AXXX	\$11,604 PR



Steel Football Goal Posts

Steel goal posts available in high school and collegiate official sizes.

- 4½" with 5' offset or 5⅙" with 6' offset models
- 2⅜" aluminum uprights, steel gooseneck and crossbar
- Adjustable in two directions ensures crossbar and uprights are level and plumb
- Permanent/semi-permanent or adjustable leveling plate installation
- Ground sleeves for semi-permanent installation sold separately, see page 47

White or Pro Yellow powder coat options. Call for freight quote.

Adjustable in two directions

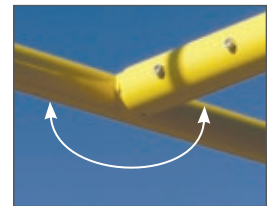
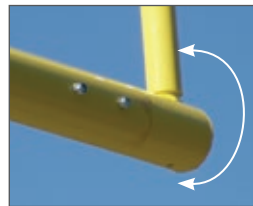

Semi-Permanent / Permanent

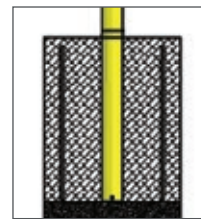

Leveling Plate

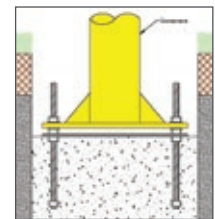

3 Year Limited Warranty



	Offset	Uprights	Color	Gooseneck	Semi-Permanent / Permanent			Leveling Plate		
					Weight	Item #	Price	Weight	Item #	Price
High School 23' 4" wide	5'	20'	Yellow	4½"	1,154 lbs	FBGP-620YW	\$4,830 PR	1,154 lbs	FBGP-600YW	\$5,954 PR
	5'	20'	White	4½"	1,084 lbs	FBGP-620	\$4,830 PR	1,080 lbs	FBGP-600	\$5,954 PR
	6'	20'	Yellow	5⅙"	1,200 lbs	FBGP-720YW	\$7,077 PR	1,200 lbs	FBGP-700YW	\$7,865 PR
	6'	20'	White	5⅙"	1,220 lbs	FBGP-720	\$7,077 PR	1,200 lbs	FBGP-700	\$7,865 PR
Collegiate 18' 6" wide	6'	20'	Yellow	5⅙"	1,100 lbs	FBGP-720XCW	\$6,504 PR	1,100 lbs	FBGP-700CW	\$7,102 PR
	6'	20'	White	5⅙"	1,140 lbs	FBGP-720C	\$6,504 PR	1,120 lbs	FBGP-700C	\$7,102 PR



FieldPro™ Football Net System

Keep field goals and extra point kicks away from spectators and inside the field. Easy-to-use pulley system raises/lowers net!

- (2) 6 $\frac{5}{8}$ " heavy-walled aluminum natural finish uprights, ground sleeves, and covers
- #36 knotted black nylon net with 3 $\frac{1}{2}$ " sq. mesh
- Pulley system and corrosion-resistant hardware included

Standard upright color is natural finish. Custom colors available upon request for additional charge. Freight quote required.

* Limited Warranties



FNFB-30	40'W x 30'H	\$4,770 EA	CALL
FNFB-40	40'W x 40'H	\$7,434 EA	CALL

* System: 3 Year Limited Warranty, Net: 1 Year Limited Warranty



30'
Raised
Height

10'
Regulation
Height

UConn's Shenkman Training Center

Stationary Ceiling Suspended Football Goal Post

Lightweight aluminum goal suspends directly beneath building structure. Great solution for indoor practice facilities!

- 6 $\frac{5}{8}$ " crossbar is official collegiate size at 18'6" wide
- 4" uprights available in 20' or 30' heights
- Crossbar leveling feature and suspension hardware included

White or Pro Yellow powder coat options. Specify post color when ordering. Call for freight quote.

3 Year Limited Warranty



CSGP-1XX	30' Uprights	Call for Pricing
CSGP-3XX	20' Uprights	Call for Pricing

Retractable Motorized Ceiling Suspended Football Goal Post

Lightweight aluminum goal suspends directly beneath building structure and lowers/raises via 1 HP electric hoist system. Great solution for indoor practice facilities!

- 6 $\frac{5}{8}$ " crossbar is official collegiate size at 18'6" wide
- 4" uprights available in 20' or 30' heights
- Crossbar leveling feature and suspension hardware included

White or Pro Yellow powder coat options. Specify post color when ordering. Call for freight quote.

3 Year Limited Warranty



CSGP-2XX	30' Uprights	Call for Pricing
CSGP-4XX	20' Uprights	Call for Pricing



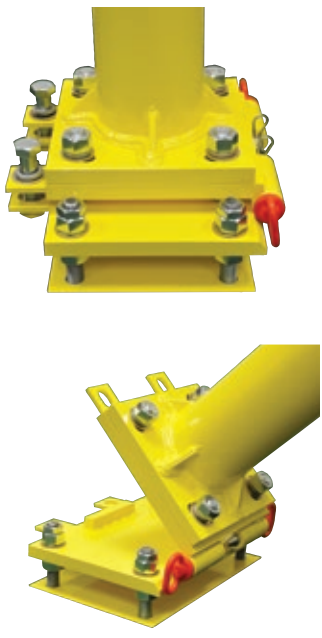

Football Hinge Kit

Allows any surface-mounted MAX-1™ football goal to be lowered and dismantled from ground level by a maintenance crew. Ideal for multi-purpose facilities!

- Opposing pull pins offer easy separation of hinge plates
- Required access frame and cover (FBGPAF-2) sold separately

3 Year Limited Warranty  

FBHG-1	\$810 EA	60 lbs
---------------	----------	--------

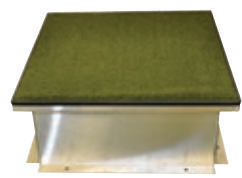

Access Frames and Covers

For use with semi-permanent goals requiring removal from grass or turf fields.

- Aluminum, pressure-treated plywood, and artificial turf design
- 2 split panels (when goal installed) and 2 full panels (when goal removed)
- 2 frames and 4 turf covered plates included
- Available in 2 sizes:
18" x 18" x 6½" (FBGPAF-1), for goals with leveling plates.
26" x 26" x 10" (FBGPAF-2), only used with Hinge Kit (FBHG-1) on MAX-1 goals.

3 Year Limited Warranty  

FBGPAF-1	\$1,444 PR	60 lbs
FBGPAF-2	\$1,665 PR	60 lbs



Soccer/Football Anchor Kit (for SGP-600AX)

Fastens soccer goal rear crossbar to football goal gooseneck.

3 Year Limited Warranty 

SFGA-6	6⅝"	\$145 KIT	10 lbs
SFGA-5	5⅞"	\$157 KIT	10 lbs
SFGA-4	4½"	\$168 KIT	10 lbs



Wind Streamers

(4) 42"L x 4"W streamers with grommets and mounting hardware.

3 Year Limited Warranty 

WS-42	\$31 SET OF 4	2 lbs
--------------	---------------	-------

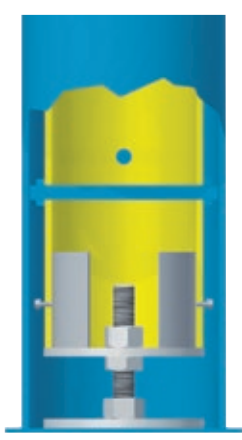

Ground Sleeves with Height Adjusters

Adjustable and easy to align.

3 Year Limited Warranty  

FBGPGS-8	For MAX-1™ Post (6⅝")	\$1,288 PR	300 lbs
FBGPGS-6	For Steel Post (5⅞")	\$1,107 PR	275 lbs
FBGPGS-5	For Steel Post (4½")	\$996 PR	250 lbs



Standard Ground Sleeves

Allows for semi-permanent installation.

3 Year Limited Warranty  

FBSLV8	For MAX-1™ Post (6⅝")	\$1,007 PR	250 lbs
FBSLV6	For Steel Post (5⅞")	\$973 PR	225 lbs
FBSLV5	For Steel Post (4½")	\$885 PR	114 lbs



Pro Style Protector Pad

- 6" thick x 6' tall
 - 14 oz. thick vinyl
 - Hook-and-loop closure
- Specify pad color when ordering. Made to order. Extended lead time.*

1 Year Limited Warranty



PPP-500	4½" pole	\$919 PR	35 lbs
PPP-700	5½" pole	\$987 PR	40 lbs
PPP-800	6½" pole	\$1,224 PR	45 lbs



Custom Graphics Available For Additional Charge



Single-Color Lettering



Multi-Color Lettering



Multi-Color Lettering with Graphics



Multi-Color Lettering with Graphics

Football Post Padding Customization

Choose from single color to full color customization on your post padding. *Extended lead time.*

JSG-FPP Multi-color lettering and graphics \$222 PER PAD



Portable Press Box

Sturdy press box ideal for coaching, filming, and press media.

- All aluminum design with weather-resistant canvas top
- Bench moves forward and backward
- 16" pneumatic wheels (2 lockable and 2 swivel)
- Canvas enclosure for inclement weather and tow kit sold separately
- 7'L x 4"W x 10'6"H

Specify canvas top color when ordering. Call for freight quote.

3 Year Limited Warranty



PPB-5	Portable Press Box	\$15,230 EA	1,380 lbs
PPB-SC	Side Curtains/Enclosure	\$1,739 EA	50 lbs
PPB-TOW	Tow Bar/Kit	\$573 EA	50 lbs

CANVAS TOP COLORS



Foldable Sideline Markers

Self-standing markers with weighted bottoms and numerals on both sides. Stores flat! Markers: 15"H x 15"W x 13"D Numbers: 13"H

1 Year Limited Warranty

FBWSM	11 Piece Set	\$454 SET	32 lbs
-------	--------------	-----------	--------

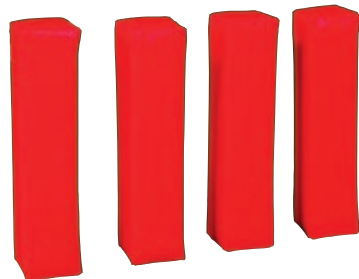

Free Standing Pylons

Self-standing end zone pylon with weighted bottom. Anchorless!
• 4"L x 4"W x 18"H

1 Year Limited Warranty

FBPYLN	4 piece	\$48 SET	13 lbs
--------	---------	----------	--------



Chain Sets

Padded bright orange targets with plated chain and swivel hooks.

1 Year Limited Warranty

8' High	FCS-8	\$371 SET	19 lbs
7' High	FCS-7	\$265 SET	15 lbs



Flip Down Indicator

Completely padded indicator with durable flip down numbers.

1 Year Limited Warranty

FFD-10	\$267 EA	12 lbs
--------	----------	--------

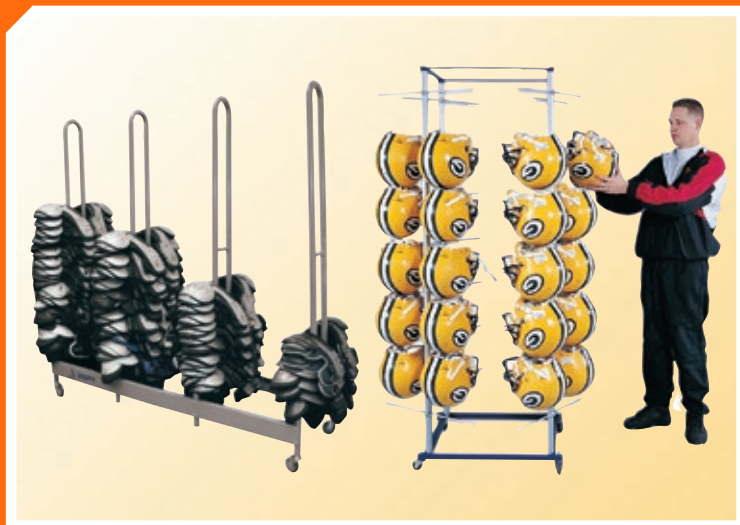

Football Equipment Storage Rack Package

- 1 StackMaster™ Deluxe Shoulder Pad Rack (SP4)
- 1 StackMaster™ Helmet Rack (H-1)

3 Year Limited Warranty

FRP-2 \$525 PKG 128 lbs

STACKMASTER™



StackMaster™ Shoulder Pad Rack

- Stores up to 42 shoulder pads
- Steel frame with non-marking swivel wheels
- 2'W x 6'6"H

3 Year Limited Warranty

SP-2 \$255 EA 37 lbs

StackMaster™ Deluxe Shoulder Pad Rack



- Stores up to 60-80 shoulder pads
- Steel frame with non-marking swivel wheels
- Removable transport handle
- 60"L x 24"W x 70"H

3 Year Limited Warranty

SP4 \$325 EA 53 lbs



StackMaster™ Helmet Rack

- Stores up to 56 helmets
- Steel frame with non-marking swivel wheels
- 2'6"W x 6'3"H

3 Year Limited Warranty

H-1 \$295 EA 66 lbs

StackMaster™ Deluxe Helmet Rack



- Stores up to 60 helmets
- Steel frame with non-marking swivel wheels
- 61"L x 24"W x 64"H

3 Year Limited Warranty

FHC-1 \$360 EA 104 lbs



Lowdown Linemen Chute

Heavy-duty chute for training linemen and backers to stay low. Great for running blocking schemes and trap drills.

- Steel frame on 12" pneumatic swivel wheels
- 42" to 66" height adjustment with telescopic legs
- Black mesh screen on lower frame is chain suspended and padded

3 Year Limited Warranty



FBLC-20	20'L x 6'W	\$3,500 EA	575 lbs
FBLC-30	30'L x 6'W	\$4,111 EA	690 lbs



Linemen Chute

Teach the basics of coming off the ball low and driving upward.

- Steel frame with pin-stop height adjustment
- Attach multiple chutes to replicate entire line
- 4'L x 5'W x 40"H to 50"H

3 Year Limited Warranty

FBLMCH	\$180 EA	47 lbs
---------------	----------	--------



Professional Portable Kicking Cage

Heavy-duty kicking cage with knotless net contains balls for warm-up exercises.

- Galvanized steel frame
- Folds down for convenient storage
- Carry bag included
- 48"W x 86"H x 48"D

* Limited Warranties

PKC-1	Cage/Net	\$544 EA	39 lbs
PKC-1N	Net	\$151 EA	5 lbs



Portable Kicking Cage

- 1 5/8" frame with 26 lb. weighted base
- Durable slip-on net included
- 48"W x 6'6"H

* Limited Warranties

PK-64	\$196 EA	31 lbs
--------------	----------	--------

* Cage: 3 Year Limited Warranty, Net: 1 Year Limited Warranty



Football Training Package

- Linemen Chute (FBLMCH)
- High Stepper Agility Trainer (FBHSTP)
- Portable Kicking Cage (PK-64)

3 Year Limited Warranty

FBTP-3

\$553 PKG

123 lbs

Round



Curved



Step Over



Round Stand-Up Blocking Dummy

- Self-standing with dense foam core
- Double reinforced 18 oz. vinyl cover
- Double web belt handles for sure grip

Specify vinyl color when ordering. Call for freight quote.

1 Year Limited Warranty

FBSUD38	14" dia. x 38"H	\$165 EA	13 lbs
FBSUD42	14" dia. x 42"H	\$179 EA	16 lbs
FBSUD48	13" dia. x 48"H	\$188 EA	18 lbs

Curved Pro Body Shield

- Pre-curved 4" thick dense foam core
 - Double reinforced 18 oz. vinyl cover
 - Double web belt handles for sure grip
- Specify vinyl color when ordering. Call for freight quote.

FBPRCV 24"H x 16"L x 4"W \$80 EA 4 lbs

Step Over Agility Dummy

- Dense foam core
- Double reinforced 18 oz. vinyl cover
- Back side handles for stand up practice

Specify vinyl color when ordering. Call for freight quote.

FBST8	48"L x 8"W x 17"D	\$171 EA	11 lbs
FBST12	48"L x 12"W x 17"D	\$214 EA	13 lbs

VINYL COLORS



High Stepper Agility Trainer

- Five adjustable heights to increase leg lift
- Steel tube frame with suspended 16 square rope grid
- Frame safely located outside running grid area
- 20'L x 6'W

3 Year Limited Warranty

FBHSTP \$220 EA 45 lbs



Shown with cone pad

SackBack Tackle Sled

- Durable steel frame with 100 lb. impact-resistant foam
 - 18 oz. vinyl cover
 - Round, cone, and attack style models
- Specify vinyl color and model style when ordering. Call for freight quote.

1 Year Limited Warranty



TKSLDV	Varsity	\$1,684 EA	225 lbs
TKSLDP	Pro	\$1,913 EA	295 lbs



Snap Attack Football Machine

Maximize time on the most difficult to practice phases of the game. See page 99 for details about this product.



Field Hockey Goal Packages

- 1 pr. Official Field Hockey Goals (FHG-2AL - Aluminum OR OFHG7124 - Steel) w/bottom boards and wheels
- 1 pr. Official Field Hockey Nets (FHND-8)

* Limited Warranties



FHG-2ALPKG	Aluminum Goal	\$3,199 PR	423 lbs
OFHG7124PKG	Steel Goal	\$2,999 PR	619 lbs

* Goal: 5 Year Limited Warranty, Wheel Kit & Bottom Boards: 3 Year Limited Warranty, Net: 1 Year Limited Warranty



Official Field Hockey Goals

Aluminum and steel goals available with or without high-density bottom boards that never fade or break.

- All welded frames for maximum stability
- Net clips (SNT-180) included
- Aluminum goal includes wheels
- Optional wheel kit (FHG-1WK) for steel goal sold separately
- Net (FHND-8) sold separately
- 12'W x 7'H x 4'D



* Limited Warranties



FHG-2AL	Aluminum w/ Bottom Boards	\$3,050 PR	400 lbs
OFHG7124	Steel w/ Bottom Boards	\$2,699 PR	570 lbs
OFHGNNB	Steel w/o Bottom Boards	\$1,650 PR	416 lbs

* Goal: 5 Year Limited Warranty, Bottom Boards: 3 Year Limited Warranty



Official Bottom Boards

Fits most field hockey goals. 18" high boards never fade or break!

- ½" thick high-density polyethylene
- Hardware included

3 Year Limited Warranty

FHG-16	\$1,254 PR	154 lbs
---------------	------------	---------



Wheel Kit

Optional tip-and-roll wheel kit for field hockey goals.

- 4 heavy-duty 10" no-flat tires
- Set modifies 1 pair of goals

3 Year Limited Warranty

FHG-1WK	\$399 KIT	24 lbs
----------------	-----------	--------



Official Field Hockey Nets

- Weatherproof 1¾" sq. mesh
- 2.5mm polyethylene material
- 12'W x 7'H x 4'D

1 Year Limited Warranty

FHND-8	\$200 PR	23 lbs
---------------	----------	--------

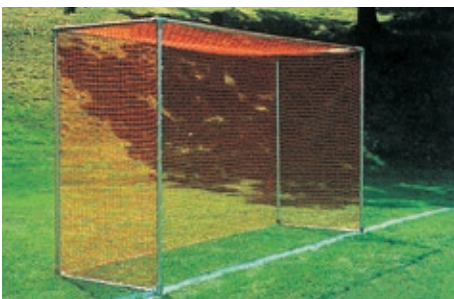

Practice Field Hockey Goal

Official size practice goal with cast aluminum corners for easy assembly.

- 1½" galvanized steel frame with net included
- 12'W x 7'H x 4'D

* Limited Warranties



PFHG-41	\$535 EA	72 lbs
----------------	----------	--------

* Goal: 3 Year Limited Warranty, Net: 1 Year Limited Warranty



Box Lacrosse Goal Package

- 2 Box Lacrosse Goals (LG-44B)
- 2 Box Lacrosse Nets (LGN-44)

* Limited Warranties

LG-44BPKG \$675 EA 98 lbs

* Goal: 3 Year Limited Warranty, Net: 1 Year Limited Warranty

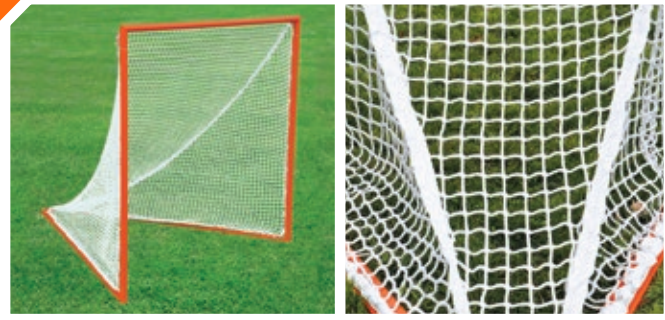

Official Lacrosse Goal Package



- 2 Official Lacrosse Goals (LG-50)
- 2 Professional Lacrosse Nets (LGN-50)

* Limited Warranties

LG-50PKG \$875 EA 196 lbs

* Goal: 3 Year Limited Warranty, Net: 1 Year Limited Warranty



Deluxe Field Lacrosse Goals

Official size goals with heavy weighted backstays are designed for professional or collegiate play.

- 2" heavy-walled steel frames with 4"W x 3/8"H base plates
- Net attaches to net rails and secured beneath cover plates
- Nets sold separately
- 6'W x 6'H x 7'D

Call for custom graphics quote to display logos and sponsors on cover plates.

3 Year Limited Warranty



LG-1X \$1,699 PR 390 lbs

Display logos and sponsors on flat cover plate





Official Box Lacrosse Goal

Official size goal for indoor/outdoor youth gameplay.

- 2" rust-proof zinc coated steel frame
- 4mm knotless net with 1½" sq. mesh w/lacing cord
- 4'W x 4'H x 4'D

*Limited Warranties

LG-44B	Goal & Net	\$337 EA	49 lbs
LGN-44	4mm Net	\$93 EA	6 lbs
LGN-44X	6mm Net	\$115 EA	7 lbs

* Goal: 3 Year Limited Warranty, Net: 1 Year Limited Warranty



Official Field Lacrosse Goal

NCAA COMPLIANT

NFHS COMPLIANT

Official size goal for men's/women's leagues.

- 2" rust-proof zinc coated steel frame
- Nets sold separately
- 6'W x 6'H x 7'D

3 Year Limited Warranty



LG-50		\$639 PR	166 lbs
LG-50HP		\$380 EA	83 lbs



Net pocket slides under backstay for secure fit



Practice Field Lacrosse Goal

Official size goal for home or practice fields.

- 1¾" steel frame
- 3.5mm net included w/lacing cord
- 6'W x 6'H x 7'D

*Limited Warranties

LG-540		\$224 EA	44 lbs
---------------	--	----------	--------

* Goal: 3 Year Limited Warranty, Net: 1 Year Limited Warranty



Lacrosse Goal Cart

Easily transports lacrosse goals up to 6'8" wide.

- Hold-down straps secure goal to cart
- Heavy-duty steel frame with black powder coat finish
- 10" tires - natural and artificial turf friendly

3 Year Limited Warranty

LG-HT		\$520 EA	65 lbs
--------------	--	----------	--------



NETX1™



Seamless One-Piece Lacrosse Net

The NETX1™ lacrosse net is the most robust and long-lasting net money can buy. Its one-piece design eliminates the most common points of failure on traditional lacrosse nets: the diagonal seams, while providing a modern aesthetic that truly sets it apart.

The UV/weather stabilized “double-needle” nylon twine has a true 7mm thickness (measured across the depth and width of the twine) with a minimum breaking strength of 770 lbs. The combination of high strength twine and lack of diagonal seams means it will outlast every other net on the market.

The included “body fit” rope adjusts the net on the goal to maintain an appropriate amount of slack so balls remain inside the goal without bouncing back out.

- Weather-stabilized 7mm x 1½” sq. knotless nylon with breaking strength of 770 lbs.
- One-piece design eliminates diagonal seams (the most common point of failure)

1 Year Limited Warranty



“Body fit” rope to adjust net slack/tension



Robust and long lasting

Item #	Goal Type	Size	Color	Weight	Price
NETX1-D260	Box	4'W x 4'H x 4'D	White	9 lbs	\$134 EA
NETX1-F160	Box	4'6" to 4'9"W x 4'H x 4' to 4'6"D	Black	12 lbs	\$134 EA
NETX1-F260	Box	4'6" to 4'9"W x 4'H x 4' to 4'6"D	White	12 lbs	\$134 EA
NETX1-G260	Field	6'W x 6'H x 7'D	White	22 lbs	\$199 EA



Professional Lacrosse Net

- 6mm knotless white net with 1½” sq. mesh
- Weatherproof polyester
- Lacing cord included
- 6'W x 6'H x 7'D



1 Year Limited Warranty

LGN-50 \$131 EA 15 lbs



Championship Lacrosse Net

- 4mm knotless white net with 1½” sq. mesh
- Weatherproof polyester
- Lacing cord included
- 6'W x 6'H x 7'D



1 Year Limited Warranty

LGN-30 \$124 EA 6 lbs



Practice Lacrosse Net

- Official size
- 3.5mm knotless net with 1½” sq. mesh
- Lacing cord included
- 6'W x 6'H x 7'D

1 Year Limited Warranty

LGN-25 \$88 EA 6 lbs



Lacrosse Rebounder

Durable steel frame rebounder with adjustable target angle for shot and passing practice.

- Target Area - 3'W x 4'H
- Frame - 4'W x 8'H

3 Year Limited Warranty

LAX-RBD \$247 EA 65 lbs



Lacrosse Training Net

Improve shooting accuracy with this training net.

- Fits any 6' x 6' goal
- Carry bag included

1 Year Limited Warranty

LAX-TN \$80 EA 6 lbs



Lacrosse Crease

Mark where attackers/midfielders should be prior to firing a shot on goal. Carry bag and ground stakes included.

3 Year Limited Warranty

LAX-C \$87 EA 6 lbs



Field ID Marker

14" sq. vinyl marker with corner grommets to number goals. Net attachments not included.

Specify vinyl color and numbers when ordering.

1 Year Limited Warranty

FIM-14 \$49 EA 1 lb

VINYL COLORS



Portable FieldPro™ Net System

Lightweight indoor/outdoor portable net system for fields and courts where in-ground/sleeve systems are not an option. Can also be used as a multi-field/court space divider!

See page 132 for details.



FieldPro™ Multi-Sport Net System

Ball stop net system for lacrosse, field hockey, and other field sports. Ensure the safety of athletes, coaches, and spectators. Easy-to-use pulley system raises/lowers net!

See page 133 for details.

BUY A BETTER CAGE!

Dealer Rated BEST In Customer Service ★★★★★

JAYPRO.COM 800-243-0533



BMR-1RB



18" Turf-Friendly Swivel Tires with Handles



Rear Wheel & Dual Coaches Stand



Thud Pad



Big League Bomber All Star



Heavy-duty portable batting cage with swivel side wheels and handles allows for easy transport in any direction.

- 2" heavy-wall aluminum tube design
- #42 weather-treated nylon net with rear net baffle
- Thud pad, 18 oz. vinyl skirt, oversized swivel tires with handles, and black ricochet padding on frame with dual observation platforms
- Open Inside Dimensions - 18'W x 12'H x 22'D
- Folded Outside Dimensions - 20'W x 6'H x 15'D
- Thud Pad - 6'W x 4'H x 4"D

SKIRT & PAD COLORS



* Limited Warranties



BMR-1RB	Royal Blue	\$5,699 EA	560 lbs
BMR-1BK	Black	\$5,699 EA	560 lbs
BMR-1RD	Red	\$5,699 EA	560 lbs
BMR-1GR	Green	\$5,699 EA	560 lbs
BMR-1NB	Navy Blue	\$5,699 EA	560 lbs

* Cage: 7 Year Limited Warranty, Net, Thud Pad, Skirt & Ricochet Padding:
1 Year Limited Warranty

Replacement Parts

Specify skirt and thud pad color when ordering.

1 Year Limited Warranty



SKT-75XX	Skirt	\$445 EA	17 lbs
BLN-3	Net	\$860 EA	44 lbs
THUD-46XX	Thud Pad	\$400 EA	20 lbs

Skirt/Thud Pad Graphics

See page 120 for product details.

Joint reinforcing clamps
for added rigidity



Ricochet Padding Upgrade Kit

- Hook-and-loop attachment that wraps around foam padding
 - Kit contains (21) 6 foot lengths
- Specify padding color when ordering.*

1 Year Limited Warranty



RPAD-UKITXX \$359 EA 10 lbs

Tow Hitch Conversion Kit

Tow batting cage with any utility vehicle.

1 Year Limited Warranty



BL-TOWKIT \$279 EA 12 lbs



Folds Down to 6' High

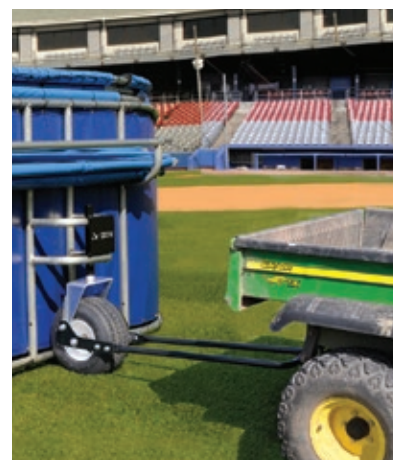

Tow Hitch Conversion Kit

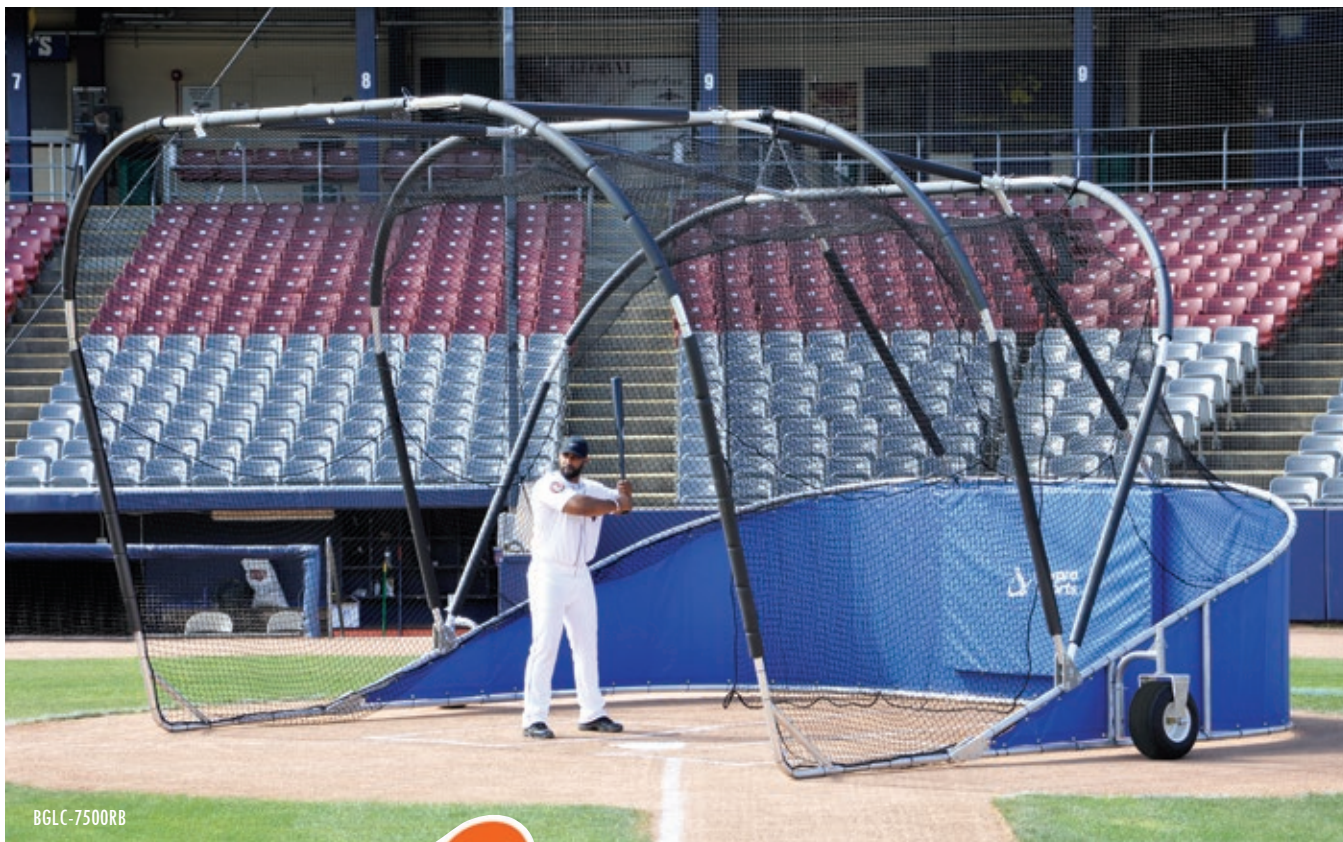

BGLC-7500RB

new

Big League Bomber Elite

Heavy-duty portable batting cage with side wheels that can be rotated and pinned 90°. Two height settings for added clearance during transport.

- 2" heavy-wall aluminum tube design
- #42 weather-treated nylon net with rear net baffle
- Thud pad, 18 oz. vinyl skirt, and black ricochet padding on frame with dual observation platforms
- Open Inside Dimensions - 18'W x 12'H x 22'D
- Folded Outside Dimensions - 20'W x 6'H x 15'D
- Thud Pad - 6'W x 4'H x 4"D

* Limited Warranties



BGLC-7500RB	Royal Blue	\$4,995 EA	546 lbs
BGLC-7500BK	Black	\$4,995 EA	546 lbs
BGLC-7500RD	Red	\$4,995 EA	546 lbs
BGLC-7500GR	Green	\$4,995 EA	546 lbs
BGLC-7500NB	Navy Blue	\$4,995 EA	546 lbs

* Cage: 7 Year Limited Warranty, Net, Thud Pad, Skirt & Ricochet Padding: 1 Year Limited Warranty

18" Oversized Turf-Friendly Tires



Strut Storage and Dual Coaches Stand



Thud Pad



SKIRT & PAD COLORS



Replacement Parts

Specify skirt and thud pad color when ordering.

1 Year Limited Warranty



SKT-75XX	Skirt	\$445 EA	17 lbs
BLN-3	Net	\$860 EA	44 lbs
THUD-46XX	Thud Pad	\$400 EA	20 lbs

Skirt/Thud Pad Graphics

See page 120 for product details.

Ricochet Padding Upgrade Kit

- Hook-and-loop attachment that wraps around foam padding
 - Kit contains (21) 6 foot lengths
- Specify padding color when ordering.

1 Year Limited Warranty



RPAD-UKITXX	\$359 EA	10 lbs
--------------------	----------	--------

Tow Hitch Conversion Kit

Tow batting cage with any utility vehicle.

1 Year Limited Warranty



BL-TOWKIT	\$279 EA	12 lbs
------------------	----------	--------



BBS-18RB



Big League Bomber Pro

Heavy-duty portable batting cage for spring training camps, semi-professional, and collegiate use.

- 2" heavy wall aluminum tube design
- #42 weather-treated nylon net with rear net baffle
- 18 oz. vinyl skirt, oversized pneumatic tires, and black ricochet padding on frame
- Observation platform (CVS-10) sold separately
- Open Inside Dimensions - 18'W x 12'H x 22'D
- Folded Outside Dimensions - 20'W x 6'H x 15'D

Specify skirt colors when ordering.

* Limited Warranties



BBS-18XX \$4,497 EA 505 lbs

* Cage: 5 Year Limited Warranty, Net, Skirt & Ricochet Padding:
1 Year Limited Warranty

Folds Down to 6' High



Strut Storage



Oversized Pneumatic Tires



Replacement Parts

Specify skirt and thud pad color when ordering.

1 Year Limited Warranty



SKT-75XX	Skirt	\$445 EA	17 lbs
BLN-3	18' x 22' x 12' Net	\$860 EA	44 lbs
THUD-46XX	Thud Pad	\$400 EA	20 lbs

SKIRT & PAD COLORS



Skirt/Thud Pad Graphics

See page 120 for product details.

Viewing Stand

View batting practice from a convenient stand attached to rear of batting cage.

3 Year Limited Warranty



CVS-10 \$570 EA 24 lbs

Ricochet Cushion

1 Year Limited Warranty



BPD-6 Black - 6' lengths \$32 EA 2 lbs

Weather Resistant Tape

1 Year Limited Warranty



PDT-3 60 yd. rolls \$75 EA 2 lbs

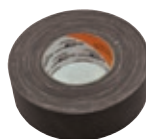



BBLS-12



Big League Bomber

Heavy-duty portable batting cage for high school and collegiate training.

- 2" heavy-wall aluminum tube design
- #42 weather-treated nylon net with rear net baffle
- Heavy-duty tires and black ricochet cushion on frame
- Folds down for convenient storage
- Optional viewing stand (CVS-10) and vinyl skirt (SKT-20XX) sold separately
- 17'6"W x 12'H x 12'D

* Limited Warranties



BBLS-12 \$4,035 EA 410 lbs

* Cage: 5 Year Limited Warranty, Net & Ricochet Cushion: 1 Year Limited Warranty

Replacement Parts

Specify skirt color when ordering.

* Limited Warranties



SKT-20XX	Vinyl Skirt	\$420 EA	23 lbs
LSN-2	Replacement Net	\$825 EA	38 lbs
CVS-10	Viewing Stand	\$570 EA	24 lbs
BPD-6	Ricochet Cushion, Black, 6' lengths	\$32 EA	2 lbs
PDT-3	Weather Resistant Tape, 60 yd rolls	\$75 EA	2 lbs

* Viewing Stand: 3 Year Limited Warranty, Skirt, Cushion, Tape & Net: 1 Year Limited Warranty

SKIRT COLORS



Line Drive Cage Net

Replacement net for the Line Drive Batting Cage.

- 16'6"W x 12'H x 16'6"D

1 Year Limited Warranty



LDN-5 \$865 EA 34 lbs



Permanent Baseball/ Softball Backstops

Galvanized steel backstops with overhang section and durable fence fabric.

- 10'W x 12'H upright sections and 10'W x 6'D overhang section
 - 2 $\frac{3}{8}$ " main uprights and 1 $\frac{5}{8}$ " crossbars
 - 9 gauge smooth galvanized fence fabric
 - All galvanized fittings, nuts, and bolts included
- Backstop sections are not prefabricated chain link. Call for freight quote.*

3 Year Limited Warranty



3 Panel Design

Item	Description	Weight	Price
BSP-30	3 Panels only	552 lbs	\$2,220 EA
BSP-30-6	3 Panels, 1 Center Overhang	682 lbs	\$2,443 EA
BSP-33-2	3 Panels, 1 Center, 2 Wing Overhangs	860 lbs	\$3,200 EA

4 Panel Design

Item	Description	Weight	Price
BSP-40	4 Panels only	727 lbs	\$2,887 EA
BSP-40-66	4 Panels, 2 Center Overhangs	956 lbs	\$3,535 EA
BSP-44-22	4 Panels, 2 Center, 2 Wing Overhangs	1,134 lbs	\$5,240 EA



BTPNS

Baseball/Softball Tensioned Backstop Net Systems

Safety tensioned backstop netting designed to not only stop the ball, but minimize net deflection. Two basic systems are available.

BTPNS Tensioned Pole to Pole Backstop Net System
Engineered structural poles support tensioned netting with fewer poles.

BPCNS Tensioned Cable Backstop Net System
Pull-back cables attached to building structure or offset pull-back poles, for a cleaner look with reduced obstructions.

Features:

- Length, height, and configuration as required
- Engineered structural poles with heights up to 40 ft.
- In-ground and surface mount pole installations available
- Systems can be free-standing or incorporated into backstop knee-wall
- Netting Options:
 - #36 knotted nylon, 1 $\frac{3}{4}$ " black sq. mesh netting
 - 1 $\frac{7}{8}$ " black knotted Dyneema (UHMWPE) sq. mesh netting, for unsurpassed strength and visibility
- Poles are powder coated black over zinc rich primer
- All hardware is galvanized

Call for more information and design assistance. Call for freight quote.

3 Year Limited Warranty

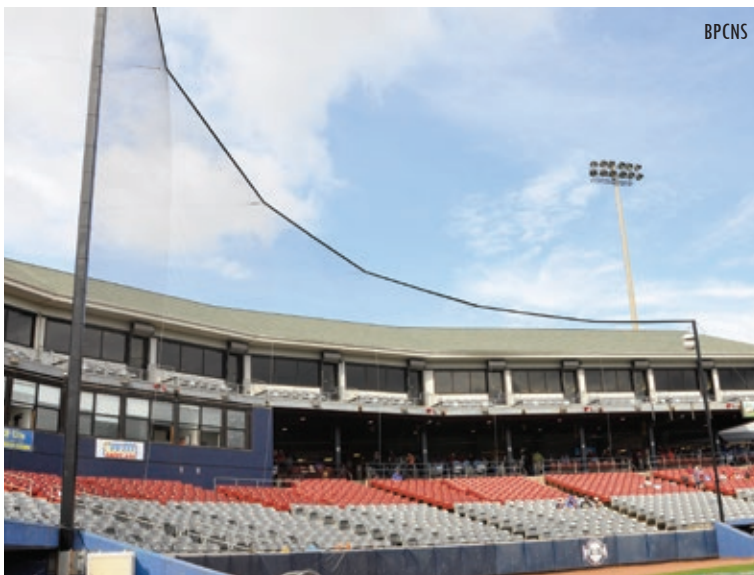

BPCNS



Shown with Optional Graphics



Backstop Padding

- 2" thick impact foam with grommet flaps on all sides for attachment to chain link fencing
 - 2' folding sections (available in solid or alternating colors)
 - Available in several sizes
 - Eco-friendly padding and optional graphics available (call for details and pricing)
 - See chart for vinyl colors (specify when ordering)
- Call for freight quote.*

1 Year Limited Warranty

Item	Weight	Size	Price	Item	Weight	Size	Price
BSP236	20 lbs	3' x 6'	\$348 EA	BSP246	25 lbs	4' x 6'	\$359 EA
BSP238	25 lbs	3' x 8'	\$359 EA	BSP248	31 lbs	4' x 8'	\$440 EA
BSP2310	30 lbs	3' x 10'	\$440 EA	BSP2410	37 lbs	4' x 10'	\$522 EA
BSP2312	35 lbs	3' x 12'	\$511 EA	BSP2412	43 lbs	4' x 12'	\$590 EA

Field Wall Padding

- 2" thick high-impact foam on 3/4" outdoor water sealed wood ply boarding
 - Available in several sizes
 - Eco-friendly padding and optional graphics available (call for details and pricing)
 - See chart for vinyl colors (specify when ordering)
- Call for freight quote.*

1 Year Limited Warranty

Item	Weight	Size	Price
FWP246	44 lbs	4' x 6'	\$457 EA
FWP248	52 lbs	4' x 8'	\$557 EA

VINYL COLORS



Batting Tunnel Turf

Ideal for batting cage floors, dugouts, baselines, bullpens, coach boxes, walkways and more.

- All turf is green and sold by the square foot
- Excess turf may be trimmed in the field

Call for freight quote.

3 Year Limited Warranty



34 oz. Poly Turf

TURF34 12'W Rolls - Unitary Backing \$2.94 SQ FT

TURF34P 12'W Rolls - 5mm Padded Backing \$4.94 SQ FT

30 oz. Nylon Turf

TURF30 15'W Rolls - Unitary Backing \$3.94 SQ FT

TURF30P 12'W or 15'W Rolls - 5mm Padded Backing \$5.94 SQ FT



TURF34



TURF34P

Batting Mat

- Indoor/outdoor use
 - Spike-resistant artificial turf with throw down home plate
 - Inlaid white lines and thick foam backing
 - 6'L x 12'W
- Call for freight quote.*

3 Year Limited Warranty



BML612G Green Turf \$475 EA 64 lbs

BML612CL Red Clay \$497 EA 64 lbs



Batting Tunnel Nets

Durable black nylon and polyethylene tunnel nets are weather-resistant and UV protected.



All-Star Series Tunnel Nylon Nets

- #36 thread count
- Twisted knotted nylon net with 1¾" sq. mesh
- ¾" twisted poly rope borders

1 Year Limited Warranty



Item	Description	Weight	Price
BBC36-7014	70'L x 14'W x 12'H	134 lbs	\$1,775 EA
BBC36-7012	70'L x 12'W x 12'H	123 lbs	\$1,599 EA
BBC36-5514	55'L x 14'W x 12'H	107 lbs	\$1,495 EA
BBC36-5512	55'L x 12'W x 12'H	100 lbs	\$1,442 EA

Major League UV Stabilized Tunnel Nets

- #42 thread count
- Knotless nylon net with 1¾" sq. mesh

1 Year Limited Warranty



Item	Description	Weight	Price
BBC-470	70'L x 14'W x 12'H	106 lbs	\$1,600 EA
BBC-370	70'L x 12'W x 12'H	102 lbs	\$1,544 EA
BBC-270	55'L x 14'W x 12'H	86 lbs	\$1,320 EA



Pro Climatized Tunnel Nets



- #42 thread count and high abrasion-resistant
 - 2.5mm twisted knot polyethylene fiber net with 1¾" sq. mesh
 - Roped perimeters and corners
- Recommended for outdoor use.*

1 Year Limited Warranty



Item	Description	Weight	Price
BBCP-7014	70'L x 14'W x 12'H	132 lbs	\$1,276 EA
BBCP-7012	70'L x 12'W x 12'H	126 lbs	\$1,099 EA
BBCP-5514	55'L x 14'W x 12'H	111 lbs	\$988 EA
BBCP-5512	55'L x 12'W x 12'H	100 lbs	\$933 EA

Collegiate Climatized Tunnel Nets

- #24 thread count
 - 2mm polyethylene fiber with 1¾" sq. mesh
 - Roped perimeters and corners
- Recommended for outdoor use.*

1 Year Limited Warranty



Item	Description	Weight	Price
BCC-7014	70'L x 14'W x 12'H	98 lbs	\$995 EA
BCC-7012	70'L x 12'W x 12'H	93 lbs	\$895 EA
BCC-5514	55'L x 14'W x 12'H	80 lbs	\$865 EA

Weighted Tunnel Sand Tubes

Keep batting tunnel nets from blowing around. Add sand easily with zippered opening!

- 18 oz. black vinyl tube (sand not included)
- 5 net attachment clips included
- 60"L x 5"W

14 sand tubes recommended for a 70'L x 12'W batting tunnel.

3 Year Limited Warranty



SWB-TUBE \$45 EA 2 lbs



PROTF-70

Professional Outdoor Batting Tunnel Frames

Clean frame design with less structure for balls to ricochet off. Individual hoist lines make for easy installation/removal of net!

- 4" aluminum tubing design
- Curved supports provide 3' offset
- Ground sleeves included
- Tunnel nets (page 65) sold separately

Design compatible with both 12' and 14' wide tunnel nets.

3 Year Limited Warranty



PROTF-70	70'L x 12'H	\$4,205 EA	400 lbs
PROTF-55	55'L x 12'H	\$4,199 EA	350 lbs

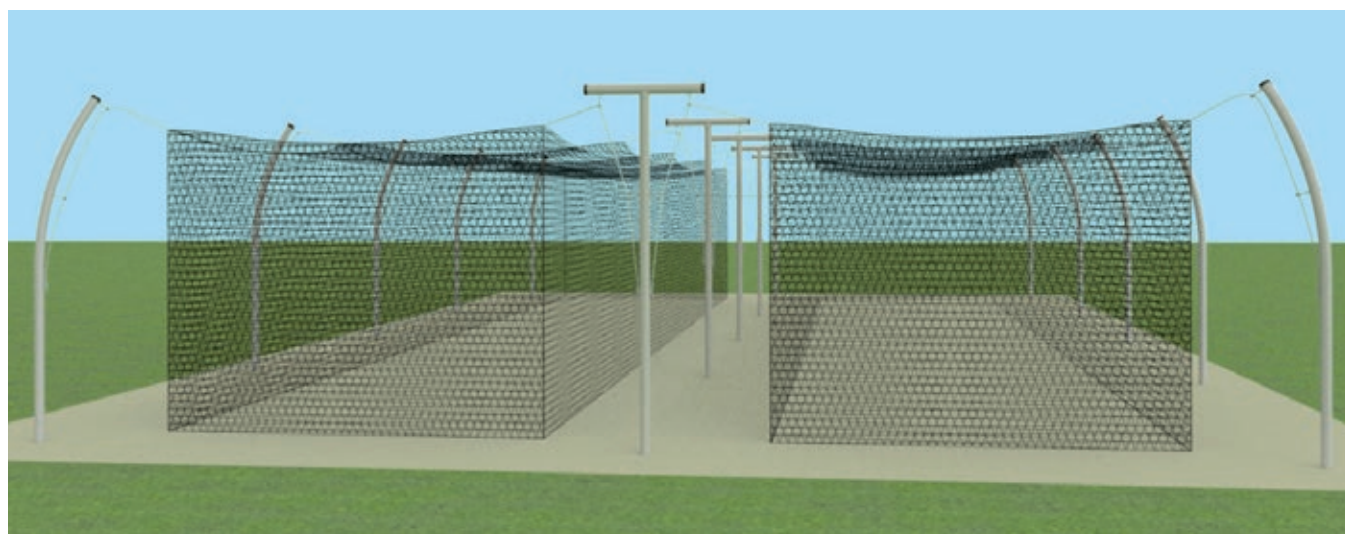

Professional Tandem Outdoor Batting Tunnel Frames

Side by side clean frame design with less structure for balls to ricochet off. Individual hoist lines make for easy installation/removal of net!

- 4" aluminum tubing design
- Curved supports provide 3' offset
- Ground sleeves included
- Tunnel nets sold separately

Design compatible with both 12' and 14' wide tunnel nets. Center supports spaced 5' apart for added safety.

3 Year Limited Warranty



PROTF-70T	70'L x 12'H	\$6,405 EA	800 lbs
PROTF-55T	55'L x 12'H	\$5,200 EA	750 lbs

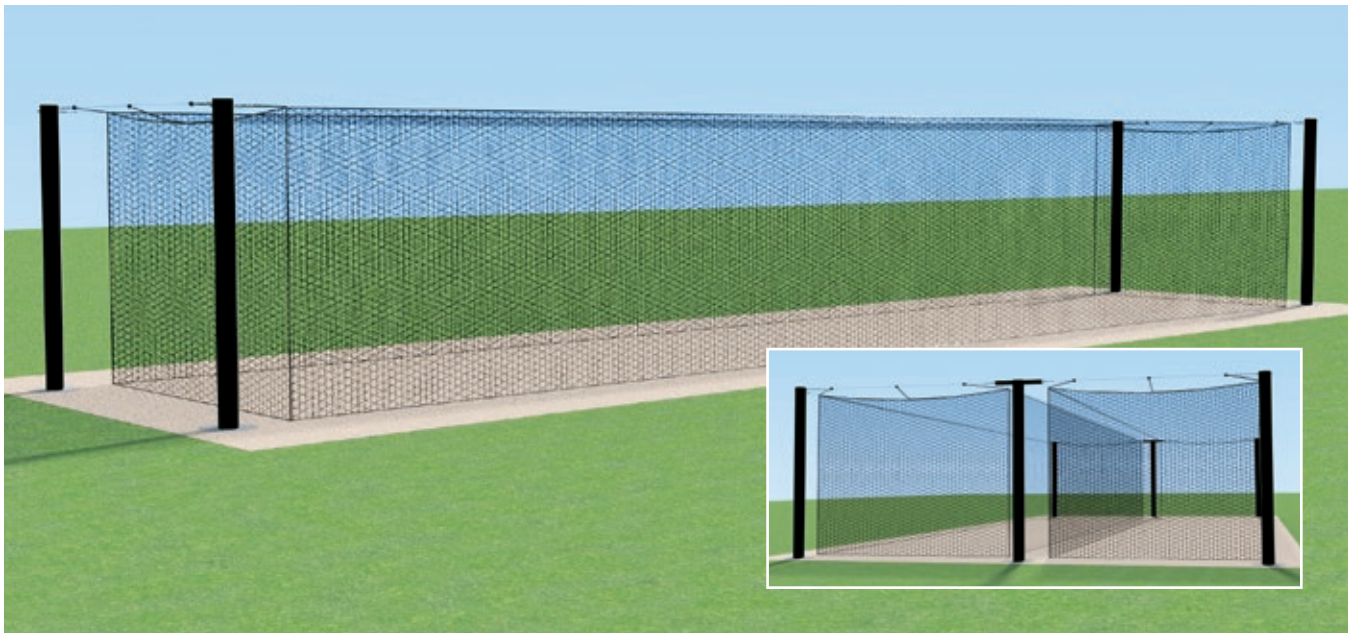

MEGA Outdoor Batting Tunnel Frames



Clean frame design with less structure for balls to ricochet off. Easily slide net to one end for storage or remove snap hooks to pack net away during the off-season!

- 8" steel pole design with black powder coat finish
- Net attaches to tensioned galvanized aircraft cable
- Single tunnel and tandem tunnel models (permanent installation)
- #36 black knotted nylon net with 1¼" sq. mesh included

3 Year Limited Warranty



MPCTF-55S	Single 55'	\$6,500 EA	1,500 lbs
MPCTF-55D	Double 55'	\$11,000 EA	2,400 lbs
MPCTF-70S	Single 70'	\$7,225 EA	1,525 lbs
MPCTF-70D	Double 70'	\$12,300 EA	2,450 lbs



Semi-Permanent Outdoor Batting Tunnel Frames

- 2" galvanized steel tubing design
- Net hangs on 3 rows of galvanized aircraft cable
- Ground sleeves included
- Tunnel nets sold separately

Design compatible with both 12' and 14' wide tunnel nets.

3 Year Limited Warranty



BBTF-70	5 Wickets - 70'L x 12'H	\$1,616 EA	250 lbs
BBTF-55	4 Wickets - 55'L x 12'H	\$1,353 EA	225 lbs

Surface-Mounted Outdoor Batting Tunnel Frames

- 2" galvanized steel tubing design
- Net hangs on 3 rows of galvanized aircraft cable
- 6" sq. surface-mount plates included
- Tunnel nets sold separately

Design compatible with both 12' and 14' wide tunnel nets.

3 Year Limited Warranty



BBTFSM-70	5 Wickets - 70'L x 12'H	\$2,550 EA	250 lbs
BBTFSM-55	4 Wickets - 55'L x 12'H	\$2,215 EA	225 lbs

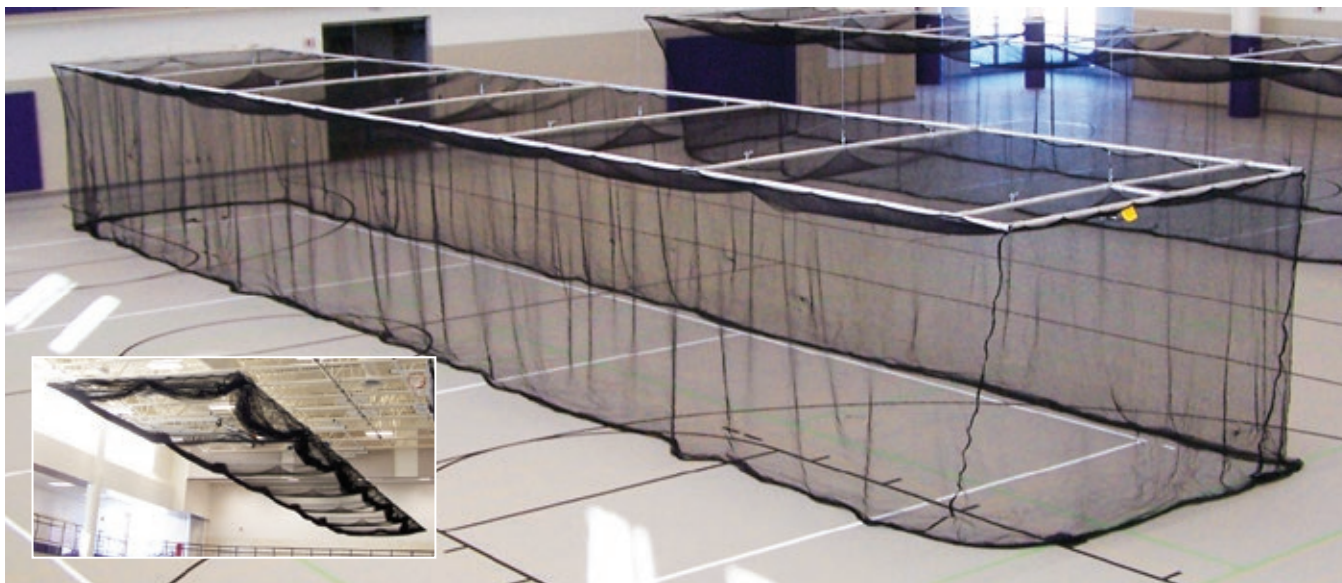

Ceiling Suspended Retractable Batting Cages

Robust indoor batting cage is raised/lowered from ceiling by an electric winch controlled drive shaft.

- 2" heavy-walled aluminum tubing design
- Tunnel net included
- Ceiling mounting kit sold separately
- 70'L x 12'W x 11'H

14' wide cages and custom sizes available. Call for quote.

* Limited Warranties



BBC-700B	Baseball - 1 3/4" mesh	\$7,450 EA	675 lbs
BBC-700M	Multi-Sport - 3/4" mesh	\$9,949 EA	675 lbs

* Cage: 3 Year Limited Warranty, Net: 1 Year Limited Warranty

Indoor Multi-Sport Tunnel Net

- Knotless nylon net with 3/4" sq. mesh
- Black net is UV stabilized
- 70'L x 12'W x 12'H

Custom sizes available. Call for quote.

1 Year Limited Warranty



BBC-700N \$2,549 EA 80 lbs

See page 65 for Baseball Tunnel Net options.



Quick Set-Up Indoor Batting Cage

Full-size batting cage attaches wall to wall by tension system. No cables or structure left behind when not in use. Sets up in minutes without a ladder!

- Marine grade rigging blocks with locking cams to both tension and lock net in position
- Wall Mounting Kit (BBC-WLKT) available if mounting to concrete or block walls

Includes hardware for attachment to most building structures. Custom sizes available upon request.

1 Year Limited Warranty



BBC-QS70	70'L x 14'W x 14'H	\$3,550 EA	130 lbs
BBC-QS55	55'L x 14'W x 14'H	\$3,250 EA	120 lbs

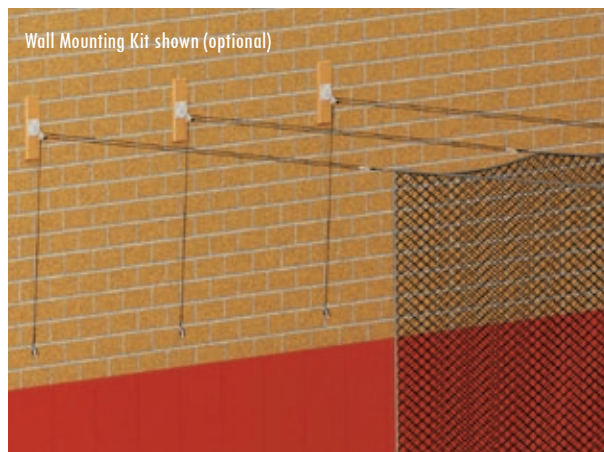

Cable Suspended Tunnel Kit

- Net suspended on aircraft cable every 3' on center
- Support cables can be placed higher in ceiling (up to 30')
- Overhead space maximized when net is stored in position
- Net and attachments sold separately

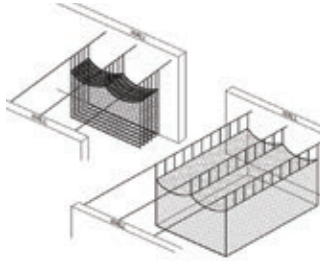

3 Year Limited Warranty



BBC-SPDKT

\$1,650 EA 100 lbs

Cable Supported Tunnel Kit

- Net attaches to cables running wall to wall
- Easily slides against wall for storage
- (3) 100' rolls of aircraft cable and hardware included
- Net and attachments sold separately

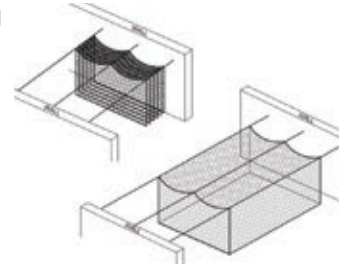

3 Year Limited Warranty



BBC-SPRTKT

\$459 EA 48 lbs

Wall Mounting Kit

- Attaches to concrete, block, or steel framed walls
- 6 finished wood pads and steel mounting plates included
- Wall anchors supplied by installer based on wall specifications

3 Year Limited Warranty



BBC-WLKT

\$1,125 EA 40 lbs

Parallel Ceiling Mounting Kit

Direct Attached:
For cages centered directly beneath a beam or bar joist (system attaches directly to single beam or bar joist).

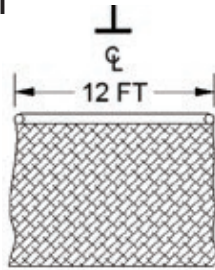

3 Year Limited Warranty



BBC-UBKIT

\$489 EA 150 lbs

Parallel Ceiling Mounting Kit

Spanning Parallel 8' on Center or Less:
For cages with a centerline located between two beams or bar joists spaced 8' apart or less.

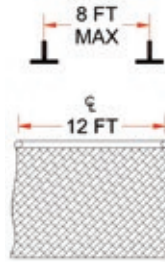

3 Year Limited Warranty



BBC-PARKITA

\$977 EA 230 lbs

Parallel Ceiling Mounting Kit

Spanning Parallel 8'-12' on Center:
For cages with a centerline located between two beams or bar joists spaced greater than 8' but not over 12' apart.

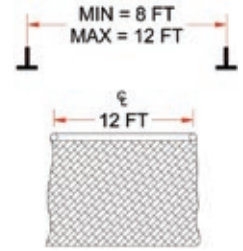

3 Year Limited Warranty



BBC-PARKITB

\$2,499 EA 515 lbs

Perpendicular Ceiling Mounting Kit

Spanning Perpendicular Not Greater Than 8' on Center:
For cages oriented perpendicular to beams or bar joists spaced no greater than 8' apart.

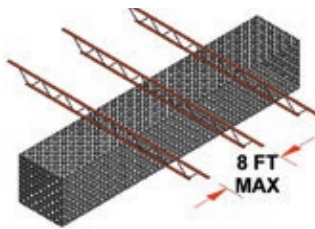

3 Year Limited Warranty



BBC-PERPKITA

\$1,845 EA 400 lbs

Perpendicular Ceiling Mounting Kit

Spanning Perpendicular 8'-12' on Center: For cages oriented perpendicular to beams or bar joists spaced greater than 8' but not over 12' apart.

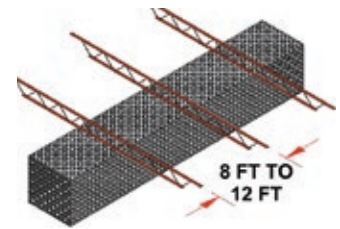

3 Year Limited Warranty



BBC-PERPKITB

\$3,064 EA 675 lbs

Rigid Frame Ceiling Mounting Kit

- Peaked or Rigid Frame Building (call for pricing)
- For cages being placed in a peaked rigid frame building
- Drive supports to be chained down from roof purlins with rigid winch support

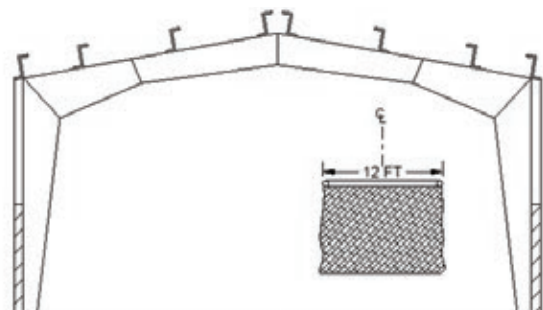

3 Year Limited Warranty



BBC-RIGKIT

Call for Pricing 650 lbs

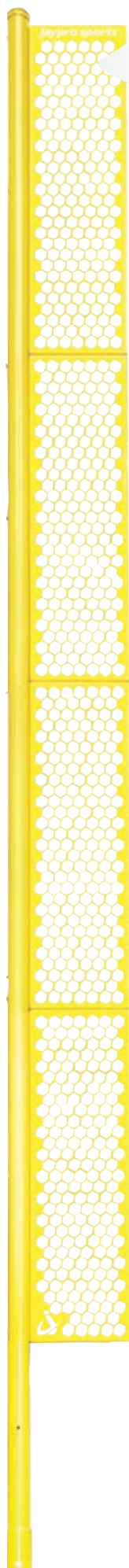

Professional Foul Poles

Baseball and softball foul poles designed to optimize air passage and engineered to withstand up to 130 mph winds! Wall-mount installation available.

20' Professional Foul Pole

- Main upright is 3½" OD Sch 40 zinc coated steel
- 18"W x 10'H bolt-on wing panel made of 11 gauge perforated steel

3 Year Limited Warranty



BBFP-20	Yellow	Permanent/Semi-Permanent	\$2,429 PR	590 lbs
BBFP-20SM	Yellow	Surface Mount	\$3,245 PR	590 lbs
SBFP-200-WT	White	Permanent/Semi-Permanent	\$2,595 PR	590 lbs
SBFP-200SM-WT	White	Surface Mount	\$3,295 PR	590 lbs
SBFP-200-OR	Orange	Permanent/Semi-Permanent	\$2,595 PR	590 lbs
SBFP-200SM-OR	Orange	Surface Mount	\$3,295 PR	590 lbs

30' Professional Foul Pole

- Main upright is 5⅝" OD Sch 40 zinc coated steel
- 18"W x 20'H bolt-on wing panel made of 11 gauge perforated steel

3 Year Limited Warranty



BBFP-30	Yellow	Permanent/Semi-Permanent	\$4,055 PR	CALL
BBFP-30SM	Yellow	Surface Mount	\$4,995 PR	CALL
SBFP-30-WT	White	Permanent/Semi-Permanent	\$4,195 PR	CALL
SBFP-30SM-WT	White	Surface Mount	\$4,595 PR	CALL
SBFP-30-OR	Orange	Permanent/Semi-Permanent	\$4,195 PR	CALL
SBFP-30SM-OR	Orange	Surface Mount	\$4,595 PR	CALL

40' Professional Foul Pole

- Main upright is 6⅝" OD Sch 40 zinc coated steel
- 18"W x 30'H bolt-on wing panel made of 11 gauge perforated steel

3 Year Limited Warranty



BBFP-40	Yellow	Permanent/Semi-Permanent	\$4,979 PR	CALL
BBFP-40SM	Yellow	Surface Mount	\$5,979 PR	CALL
SBFP-40-WT	White	Permanent/Semi-Permanent	\$4,979 PR	CALL
SBFP-40SM-WT	White	Surface Mount	\$5,979 PR	CALL
SBFP-40-OR	Orange	Permanent/Semi-Permanent	\$4,979 PR	CALL
SBFP-40SM-OR	Orange	Surface Mount	\$5,979 PR	CALL

See page 71 for optional ground sleeves for semi-permanent installation.



Outfield Distance Markers

- Printed digitally on 13 oz. reinforced vinyl fabric
- Marker Colors: Forest Green, Red, Yellow, Royal Blue, Gray, Tan and Black
- Number Colors: White, Yellow, Black and Blue

Specify vinyl color, numbers, and number color when ordering.

1 Year Limited Warranty



ODM-23	27" x 36" Marker w/ 18" Numbers	\$145 EA	4 lbs
ODM-35	38" x 56" Marker w/ 24" Numbers	\$173 EA	6 lbs

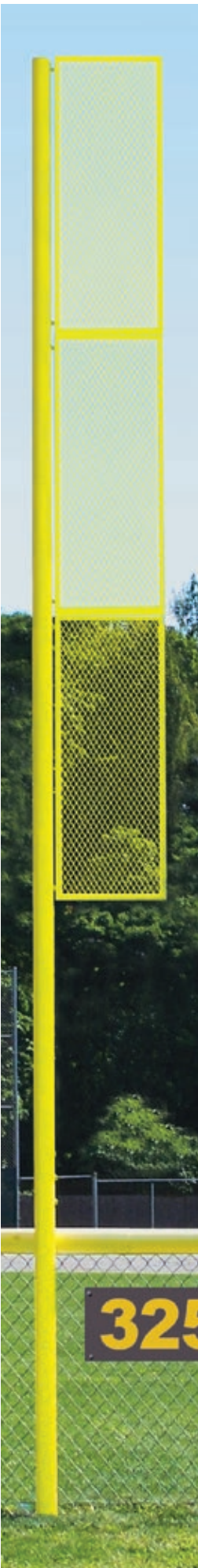

Collegiate Foul Poles

Baseball and softball foul poles with a zinc undercoating and powder coat finish. Designed for permanent and semi-permanent (with optional sleeve) installation. Surface mount and wall-mount installation available!

12' Baseball/Softball Foul Pole

- 3½" heavy-duty steel tube pole
- 18"W x 6'H bolt-on steel wing panel

3 Year Limited Warranty



BBSBFP-12	Yellow	Permanent/Semi-Permanent	\$999 PR	200 lbs
SBCFP-12-WT	White	Permanent/Semi-Permanent	\$1,105 PR	200 lbs
SBCFP-12-OR	Orange	Permanent/Semi-Permanent	\$1,105 PR	200 lbs

15' Collegiate Foul Pole

- 3½" heavy-duty steel tube pole
- 18"W x 6'H bolt-on steel wing panel

3 Year Limited Warranty



BBSBFP-15	Yellow	Permanent/Semi-Permanent	\$1,298 PR	235 lbs
SBCFP-15-WT	White	Permanent/Semi-Permanent	\$1,373 PR	235 lbs
SBCFP-15-OR	Orange	Permanent/Semi-Permanent	\$1,373 PR	235 lbs

20' Collegiate Foul Pole

- 3½" heavy-duty steel tube pole
- 18"W x 12'H bolt-on steel wing panel



3 Year Limited Warranty



BBCFP-20	Yellow	Permanent/Semi-Permanent	\$1,499 PR	317 lbs
SBCFP-200-WT	White	Permanent/Semi-Permanent	\$1,610 PR	317 lbs
SBCFP-200-OR	Orange	Permanent/Semi-Permanent	\$1,610 PR	317 lbs

30' Collegiate Foul Pole

- Two-piece telescoping design
- 4½" heavy-duty steel tube pole
- 18"W x 18'H bolt-on steel wing panel

3 Year Limited Warranty



BBCFP-30	Yellow	Permanent/Semi-Permanent	\$2,895 PR	CALL
SBCFP-30-WT	White	Permanent/Semi-Permanent	\$2,854 PR	CALL
SBCFP-30-OR	Orange	Permanent/Semi-Permanent	\$2,854 PR	CALL

Surface Mount and Wall Mount Installation Available

Foul Pole Ground Sleeves

For semi-permanent installation of foul poles. Facilitates easy installation and maintenance!

3 Year Limited Warranty



FPS-12	12' or 15' Sleeves	\$251 PR	18 lbs
FPS-20	20' Sleeves	\$349 PR	24 lbs
FPS-30C	30' Sleeves (for BBCFP-30 poles)	\$365 PR	36 lbs
FPS-30P	30' Sleeves (for BBFP-30 poles)	\$559 PR	36 lbs
FPS-40	40' Sleeves (for BBFP-40 poles)	\$645 PR	50 lbs



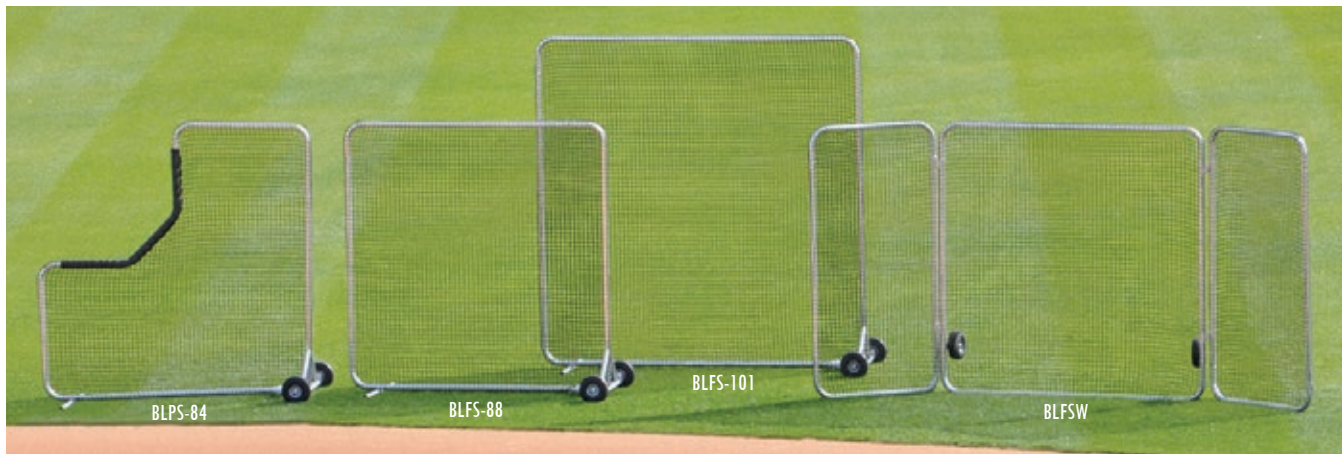

Big League Screens

Larger size screens for pro players protects fielders from stray balls.

- 2" heavy-walled Schedule 40 aluminum design
- #42 knotless weatherproof double-sided slip-on net
- (2) 10" dia. x 4" wide no-flat tires

* Limited Warranties



* Screen: 3 Year Limited Warranty, Net: 1 Year Limited Warranty

Big League Pitchers Screen

- Heavy-duty welded leg supports
- Padded hip protector included
- Wheels included with frame

BLPS-84	8'x8'	\$614 EA	85 lbs
BLPS-84N	8'x8' Net	\$222 EA	5 lbs

Big League Fungo Screen

- Heavy-duty welded leg supports
- Available in two sizes
- Wheels included with frame

BLFS-88	8'x8'	\$648 EA	75 lbs
BLFS-101	10'x10'	\$768 EA	83 lbs
BLFS-88N	8'x8' Net	\$230 EA	3 lbs
BLFS-101N	10'x10' Net	\$274 EA	4 lbs

Big League Fungo Screen with Wings

- Wings fold in for easy transport
- Center - 8'W x 8'H
- Wings - 4'W x 8'H

BLFSW	Screen	\$1,076 EA	77 lbs
BLFSW-N	Wing Net	\$130 EA	3 lbs
BLFS-88N	Center Net	\$230 EA	3 lbs

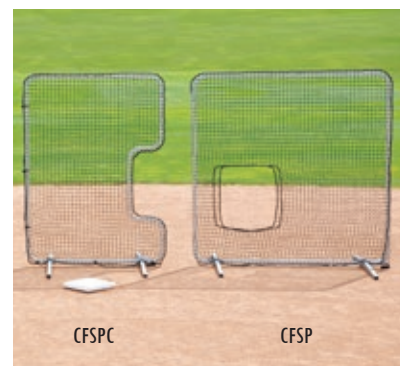
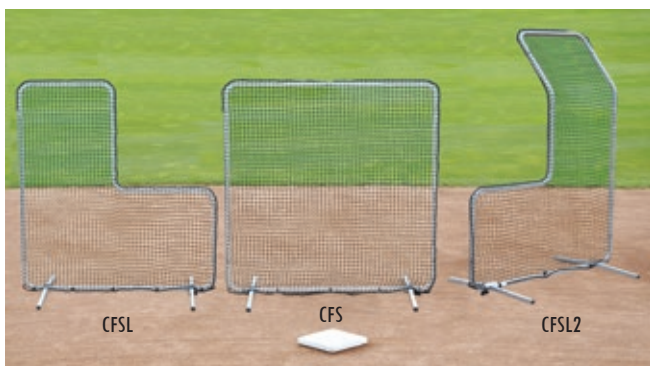

Classic Baseball & Softball Screens



Galvanized steel square frames with heavy-duty pillow-case style netting.

- Nut/bolt assembly with detachable leg supports
- Swaged joints for easy assembly
- Optional wheel kit (CFS-WK) sold separately

* Limited Warranties



* Screen: 3 Year Limited Warranty, Net: 1 Year Limited Warranty

CFSL	Baseball L Screen - 7' x 7'	\$279 EA	85 lbs
CFS	Baseball Fielders Screen - 7' x 7'	\$299 EA	85 lbs
CFSL2	Baseball L2 Screen - 9' x 7'	\$309 EA	85 lbs
CFS-WK	Wheel Kit	\$109 EA	12 lbs

CFSST	Baseball/Softball Soft Toss - 7' x 7'	\$299 EA	85 lbs
CFSPC	Softball C Shape - 7' x 5'	\$289 EA	85 lbs
CFS	Softball Pitching Protector - 7' x 7'	\$309 EA	85 lbs

Required protection screens for players during batting and fielding practice.



Collegiate Pitchers Screen

- 1 5/8" heavy gauge galvanized steel design
- 2" sq. galvanized steel legs and (2) 8" dia. wheels
- #36 knotless weatherproof double-sided slip-on net

* Limited Warranties

PS-84	7' x 7' Screen	\$324 EA	73 lbs
PS-84N	7' x 7' Replacement Net	\$131 EA	6 lbs

Collegiate Fielders Screen

- 1 5/8" heavy gauge galvanized steel design
- 2" sq. galvanized steel legs and (2) 8" dia. wheels
- #36 knotless weatherproof double-sided slip-on net

* Limited Warranties



FS-77	7' x 7' Screen	\$270 EA	67 lbs
FS-101	10' x 10' Screen	\$376 EA	84 lbs
FS-77N	7' x 7' Replacement Net	\$133 EA	7 lbs
FS-101N	10' x 10' Replacement Net	\$167 EA	4 lbs

* Screens: 3 Year Limited Warranty, Nets: 1 Year Limited Warranty



Softball Protector Screen

- For softball pitchers
- Net and wheel kit included
- 7'W x 7'H frame with cutout

* Limited Warranties

SBPE-77	7' x 7' Screen	\$330 EA	52 lbs
SBPE-77N	7' x 7' Repl. Net	\$125 EA	6 lbs



Portable Soft Toss/Batting Practice Screen

- Heavy-duty frame for baseball/softball practice
- Balls collect in sock for reuse
- Pillowcase style net and wheel kit included

* Limited Warranties

PSTS-77	7' x 7' Screen	\$293 EA	54 lbs
PSTS-77N	7' x 7' Replacement Net	\$179 EA	3 lbs
PSTS-76N	7' x 6' Green Economy Net	\$99 EA	3 lbs



Short Sided Pitchers Screen

- Narrow width for use in batting tunnels or indoors
- 1 5/8" heavy gauge galvanized steel design
- 2" sq. galvanized steel legs
- #36 knotless weatherproof double-sided slip-on nylon net

* Limited Warranties

PS-75	Screen	\$493 EA	65 lbs
PS-75N	Replacement Net	\$153 EA	3 lbs



Pro-Style Hollywood Bases

Used by the pros and ideal for advanced levels of play.

- 3 bases with a tapered lip that digs into the dirt
- 3 anchors and (3) 1½" solid rubber plugs included
- 15" x 15" x 3"

3 Year Limited Warranty

BB-500 \$200 SET 42 lbs



Breakaway Style Bases

Fully compliant with Little League® Rule 1.06

- 3 quick release bases disengage upon impact
- 3 anchors and 1½" solid rubber plugs included
- 15" x 15" x 3"

3 Year Limited Warranty

BB-700 \$333 SET 42 lbs

Recreation Double First Base



- Foam-filled with nylon quilted cover
- Straps and 3 spikes included
- 30" x 15" x 3"

3 Year Limited Warranty

BB-150 \$56 EA 6 lbs

Official Size Economy Bases



- 3 foam-filled bases with heavy-duty quilted covers, straps and anchors
- 15" x 15" x 3"

3 Year Limited Warranty

BB-100 \$68 SET 10 lbs



Home Plate Extension

- Provides an extended strike zone
- More visible for umpires to make calls
- White molded vinyl composition

3 Year Limited Warranty

HPEXT \$24 EA 7 lbs



Flex Style Bases

Ideal for recreational or competition levels of play.

- 3 impact bases are shock absorbing and compress on impact
- 3 anchors and (3) 1½" solid rubber plugs included
- 15" x 15" x 3"

3 Year Limited Warranty

BB-200 \$222 SET 38 lbs



Flex Style Double First Base

- Double first base reduces collisions and compresses on impact
- 2 anchors and (2) 1½" solid rubber plugs included
- 30" x 15" x 3"

3 Year Limited Warranty

BB-400 \$167 EA 32 lbs



Rubber Throw Down Home Plate & Bases

- Heavy-duty molded rubber with waffle bottom
- Bases are 13½" square and ½" thick

3 Year Limited Warranty

HP-300 Home Plate \$22 EA 6 lbs

BB-350 Bases (Set of 3) \$44 SET 11 lbs



Throw Down Bases

- Flexible and washable rubber bases for indoor/outdoor use
- 3 bases, home plate and pitching rubber included

3 Year Limited Warranty

BB-50 \$19 SET 8 lbs



HP-200

best seller



HP-250

Major League Home Plate

- Durable molded rubber design
- Stanchion-mounted steel plate
- Removes easily for maintenance and storage

3 Year Limited Warranty

HP-200	Plate w/ 1½" Anchor		
	\$111 EA	14 lbs	
HP-250	Plate w/ 5 Zinc-Plated Spikes		
	\$144 EA	12 lbs	



best seller

Professional Pitching Rubbers

- Durable molded rubber design
- Interior PVC tube increases longevity
- Fill with dirt or concrete for added stability

3 Year Limited Warranty

PR-624	Major League - 6" x 24"		
	\$111 EA	21 lbs	
PR-618	Little League - 6" x 18"		
	\$88 EA	19 lbs	

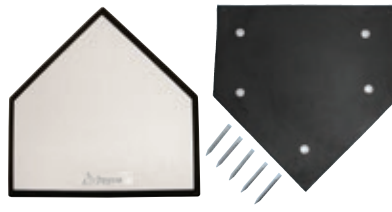

Economy Home Plate

- Durable molded rubber construction
- 5 removable spikes included

3 Year Limited Warranty

HP-50	\$37 EA	11 lbs
--------------	---------	--------

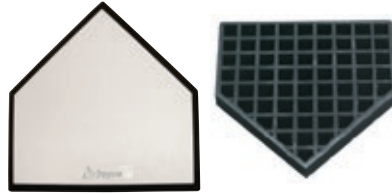

Bury-All Home Plate

- Rubber design with no corners/edges to catch spikes
- No-skid waterproof surface

3 Year Limited Warranty

HP-100	\$99 EA	25 lbs
---------------	---------	--------



Bury-All Home Plate

- Wood-filled design with no corners/edges to catch spikes
- No-skid waterproof surface

3 Year Limited Warranty

HP-150	\$111 EA	24 lbs
---------------	----------	--------

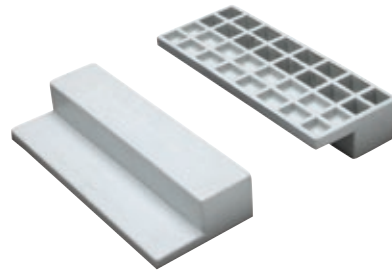

Step Down Pitching Rubbers

- Heavy-duty all rubber design
- Step down style for better footing

3 Year Limited Warranty

PR-524	Official - 24" long		
	\$91 EA	19 lbs	
PR-518	Youth - 18" long		
	\$77 EA	10 lbs	

Step Down Pitching Rubbers

- Heavy-duty wood-filled design
- Step down style for better footing

3 Year Limited Warranty

PR-550	Official - 24" long		
	\$102 EA	19 lbs	



Removable Pitching Rubbers

- Heavy molded rubber
- Steel ground anchors included

3 Year Limited Warranty

PR-424	Official - 24" long		
	\$85 EA	15 lbs	
PR-418	Youth - 18" long		
	\$74 EA	9 lbs	

Movable Pitching Rubber

- Heavy molded rubber
- 3 removable metal spikes included

3 Year Limited Warranty

PR-324	Official - 24" long		
	\$24 EA	12 lbs	
PR-318	Youth - 18" long		
	\$20 EA	10 lbs	



StackMaster™ Professional Base Package

- Pro-Style Hollywood Bases (BB-500)
- StackMaster™ Professional Base Cart (BBCART)

3 Year Limited Warranty

BCARTSET \$350 EA 72 lbs



STACKMASTER™

Professional Base Cart

Transports and stores heavy pro bases and male/female receptacles.

- Heavy-duty square steel frame
 - Pneumatic tires for easy mobility
- Cannot be used with Flex Style Bases (BB-200) or Double First Bases (BB-400).*

3 Year Limited Warranty

BBCART \$250 EA 30 lbs

Cleat Cleaner

- Polyurethane design with molded handle
- 4 steel spikes included
- 8 rows of 13 spikes (14" x 19½")

3 Year Limited Warranty

CLTCLN \$50 EA 5 lbs



Pre-Assembled Anchor Foundation

- Pre-assembled recycled rubber base foundation is ready to install
- Fits 1½" anchors and includes a polycarbonate stem
- Base(s) sold separately

For Hollywood, Magnetic, Bolco Style Bases. Call for freight quote.

1 Year Limited Warranty

PABF1 Single \$74 EA 3 lbs
 PABF3 Set of 3 \$193 SET 20 lbs

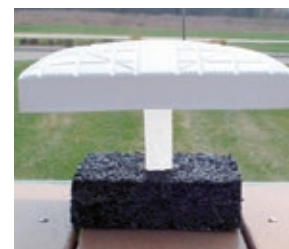

Replacement Parts

3 Year Limited Warranty

Base Dig-Out Tool

BB-DIGOUT \$17 EA 1 lb

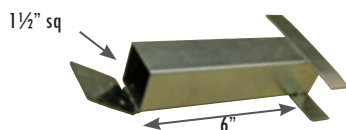
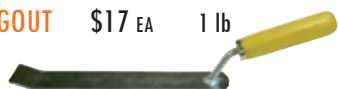

Base Anchors

BB-ANCHOR \$11 EA 1 lb

Replacement Stancion

- For BB-200 and BB-400

BB-RAP

\$10 EA 1 lb



Base Rubber Plug

BB-PLUG \$10 EA 1 lb



1 3/4" Base Anchors (Set of 3)

BB-ANCHOR175

\$40 SET 2 lbs



1 1/2" Base Anchor

BB-ANCHOR150

\$14 EA 3 lbs

Big League Base Plug

- For both 1½" and 1¾" sleeves
- Order 3 for a complete set

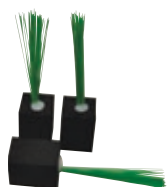

BB-BLBP

\$14 EA 1 lb



Ball Cart

- Heavy-duty steel ball cart with oversized no-flat wheels
- 17"W x 16"H x 24"D

3 Year Limited Warranty

BCT-100 \$225 EA 35 lbs



Carry Bag

- Stores up to 64 baseballs or 36 softballs - strap included
- 12"W x 14"H x 12"D

3 Year Limited Warranty

RBF-BASE \$34 EA 3 lbs



Hanging Bat Rack

- Heavy-duty galvanized steel bat rack holds up to 14 bats
- Attaches to dugout fence or wall with included hardware

3 Year Limited Warranty

PBR-14WM \$139 EA 5 lbs



Junior Mounds



Convert a softball field to a youth baseball field. Meets official Little League height specifications!

- Indoor/outdoor design with spike-proof 75 oz. artificial turf - pitching rubber included

Call for freight quote.

1 Year Limited Warranty



Junior Game Mound (9'L x 5'4"W x 6"H)

PPM-660G Green \$1,536 EA 145 lbs

PPM-660CL Clay \$1,500 EA 145 lbs

Pony Game Mound (54"L x 49"W x 6"H)

PPM-652G Green \$722 EA 50 lbs

PPM-652CL Clay \$725 EA 50 lbs



Deluxe Batting Tee

- Durable official size home plate and telescoping height of 22" to 37" (approx.)
- Baseball not included

3 Year Limited Warranty

BT-4 \$39 EA 7 lbs



Cage Saver Target

Heavy-duty 40 oz. reinforced vinyl tarp with strike zone.

- Grommets and hanging straps included
- 5'W x 6'H

1 Year Limited Warranty

CST65 \$89 EA 11 lbs

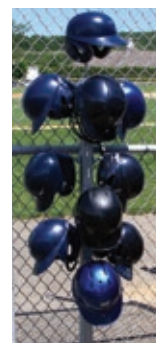

StackMaster™ Batting Helmet Storage Rack

- Galvanized steel frame stores up to 12 helmets
- Anchor to ground is recommended for secure installation

3 Year Limited Warranty

BHR-1 \$251 EA 32 lbs

Field Covers • Rolling Tubes Fitted Sideline Covers

Assorted sizes and colors available.
Call customer service for details and freight quotes.



Weighted Spot Covers

- 6 oz. polyethylene cover with weighted hem - stakes/sand bags not required
- White/silver reversible colors

Call for freight quote.

1 Year Limited Warranty

Item	Weight	Description	Price
WWMC18	39 lbs	18' round	\$517 EA
WWMC20	44 lbs	20' round	\$582 EA
WWMC26	63 lbs	26' round	\$793 EA

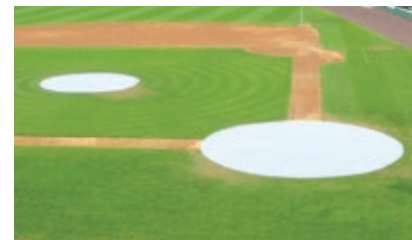
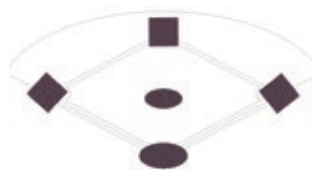

Spot Covers

- 6 oz. rip-resistant woven polyethylene covers
- Heat sealed for waterproof protection
- Grommets spaced at 3' to 4' intervals
- Stakes included
- White/silver reversible colors

Call for freight quote.

1 Year Limited Warranty

Item	Weight	Description	Dimensions	Price
AFC-PM	19 lbs	Pitcher's Mound (7 stakes)	20' Round	\$296 EA
AFC-HP	30 lbs	Home Plate (9 stakes)	26' Round	\$417 EA
AFC-BC3	24 lbs	3 Bases (15 stakes)	10' x 10' Square	\$274 SET



Premium Wind Screen

14 oz. / sq. yd. vinyl coated polyester mesh provides 75% shade.

- IncrediSeal™ heat sealed hems
- Grommets spaced every 18"
- Color options: Dark Green, Royal Blue, Red, Light Gray, Kelly Green, Maroon, Navy Blue, Purple, Orange, Carolina Blue, Yellow, and White.
- Graphics available
- Wind vents and cable ties sold separately

Call for freight quote.

5 Year Limited Warranty

WSCRN-6	6' Height	\$1.07 SQ FT
WSCRN-9	9' Height	\$1.10 SQ FT

TuffPrint Lettering and Logos

WSCRNLG Call for Details and Pricing



Classic Wind Screen

8 oz. / sq. yd. vinyl coated polyester mesh provides 84% shade.

- IncrediSeal™ heat sealed hems
- Grommets spaced every 18"
- Graphics available
- Wind vents and cable ties sold separately
- Color options: Forest Green, Royal Blue, Black, Red, Navy Blue, Orange, Maroon, Carolina Blue, Brown, Tan, Purple, Kelly Green, White, Gray, and Yellow.

Call for freight quote.



3 Year Limited Warranty

Item	Description	Price
TWS-6	6'H Screen	\$.82 SQ FT
TWS-9	9'H Screen	\$.94 SQ FT
PCT-100	Plastic Cable Ties	\$14 SET OF 100
HMV-18	Half Moon Wind Flap	\$6 EA

Maximum length of a single piece wind screen is 100'. Screens over 100' will be made in sections. Custom heights above 6' will be charged at 9' pricing. Heights cannot exceed 9'. Wind screens higher than 6' require a centered horizontal lacing lip along entire length.

Temporary Fencing Available One-Piece Kits for Baseball & Softball

Call customer service for details and freight quotes.



COLORS



Poly-Cap Fence Top Protection

- 4½" dia. pre-slit corrugated polyethylene for durability and UV protection
 - Secure with tie wraps every 2' (sold separately)
 - Colors: Yellow (YW), Orange (OR), Forest Green (GR), Black (BK)
- Call for freight quote.

2 Year Limited Warranty



Item	Weight	Description	Price
CFC-100XX	35 lbs	100' Coil Fence Crown	\$179 EA
CFC-250XX	85 lbs	250' Coil Fence Crown	\$284 EA
CFC-TIESXX	1 lb	19" Ties (Bag of 100)	\$57 SET
CFC-ITOOOL	7 lbs	Installation Tool	\$82 EA



Fence Guard

- Maintenance free exterior grade UV-resistant polyethylene
 - Set of (12) 7' sections are pre-drilled every 2'
 - Available in 6 colors
 - Fence guard ties included
- Call for freight quote.

COLORS



3 Year Limited Warranty 

STC-8XX \$190 SET 22 lbs



Safefoam Tubular Padding

- Tubular thick foam padding with durable skin coating
- Fits any 2½" dia. or less round pipe
- 8' long sections pre-slit for installation
- Minimum order of 6 pieces
- Secure with tie wraps every 2' (sold separately)

Call for freight quote.



1 Year Limited Warranty



Item	Yellow	Royal Blue	Red	Green	Price
Padding	SF-PREMYW	SF-PREMRB	SF-PREMRD	SF-PREMRG	\$64 EA
100 Ties	SF-TIESYW	Call for more color options.			\$45 SET

Deluxe FenceTop & Rail Padding

- 2" thick foam in 6' long sections encased in 18 oz. vinyl
 - Fits 2" outside diameter pipe
 - Grommets every 6" for attachment
 - Color options: Maple Green, Royal Blue, Red, Navy Blue, Gray, Maroon, Sky Blue, Purple, Yellow, White, Tan, Black, Kelly Green and Orange
- Call for freight quote.

3 Year Limited Warranty

PRAFTP6 \$216 PER 6' SECTION 7 lbs





Batting Cage Sun Canopy

- 25'6" L x 6' W with hemmed perimeter and grommets
- Made from 8.2 oz./sq. yd. PVC coated polyester wind screen
- Bungee loops for easy attachment included

Call for freight quote.

3 Year Limited Warranty

BBBCSC \$290 EA 30 lbs



Batter's Box Template

- Lightweight aluminum frame template imprints 2" pattern for chalking
- Carry handle aligns with home plate for proper positioning
- Folds for easy transport and storage

1 Year Limited Warranty

BBTMOFF	Official - 4' x 6'	\$277 EA	17 lbs
BBTMLL	Little League - 3' x 6'	\$277 EA	18 lbs
BBTMSB	Softball - 3' x 7'	\$277 EA	18 lbs

See page 82 for our smaller field markers (FLMR-10) and (FLMR-25) to mark out your Batter's Box Template.

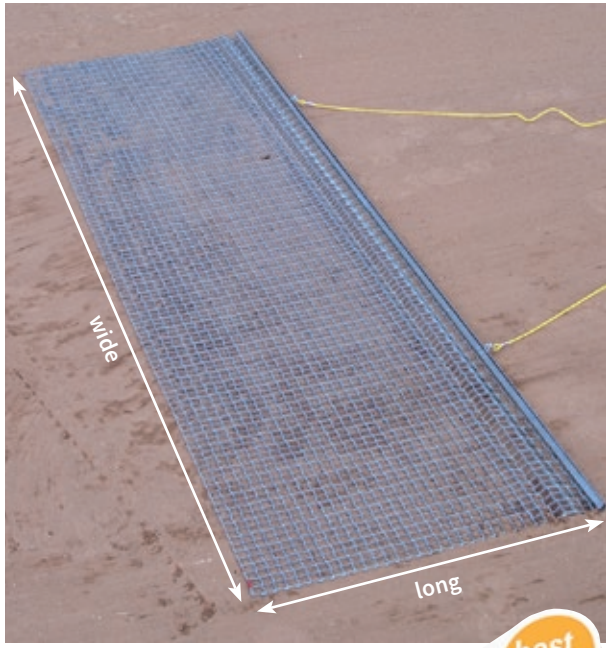

Infield Drag Mat

- Flexible plated steel mesh mat with 1 1/16" galvanized steel drag bar
- 3/8" polypropylene rope handle

1 Year Limited Warranty

DM-34	4'L x 3'W	\$150 EA	27 lbs
DM-5	3'L x 5'W	\$170 EA	31 lbs
DM-63	3'L x 6'W	\$240 EA	36 lbs
DM-6	6'L x 6'W	\$349 EA	65 lbs



Monster Drag Broom

- Heavy-duty aluminum construction with foam covered handle
- 7' head with 2 rows of removable bristles

Double Play Monster Drag Broom

- Heavy-duty aluminum construction with foam covered handle
- 7' head with scarifying edge and 2 rows of removable bristles

1 Year Limited Warranty

MDB-84	Monster	\$236 EA	16 lbs
DPMDB-84	Double Play	\$300 EA	12 lbs



Double Play Scarifier Broom

- Aluminum powder coated blue handle
- 28" head with scarifying edge and two rows of removable bristles

1 Year Limited Warranty

DPSB-28		\$142 EA	7 lbs
----------------	--	----------	-------



Base Runner Rake

Lightweight aluminum/magnesium alloy rake breaks down for convenient storage.

- Telescopic fiberglass handle adjusts from 30" to 70"
- 36" grading edge with teeth

1 Year Limited Warranty

BRR-36		\$122 EA	6 lbs
---------------	--	----------	-------

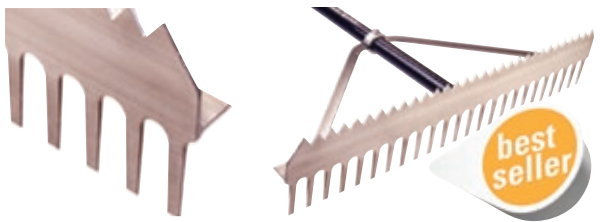

Double Play Rake

- High-grade aluminum head and bracing
- 66" powder coated aluminum handle with 5" no-slip vinyl grip

1 Year Limited Warranty

DPR-24	24" Rake	\$82 EA	5 lbs
DPR-36	36" Rake	\$90 EA	6 lbs

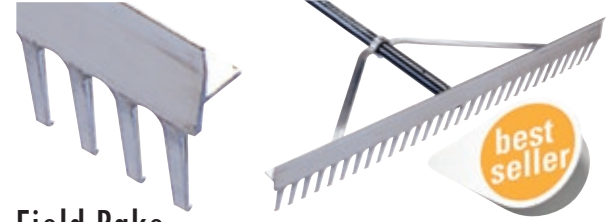

Field Rake

- 66" lightweight aluminum/magnesium alloy head construction
- Large grading edge with heavy-duty cleaning teeth

1 Year Limited Warranty

FR-24	24" Rake	\$70 EA	5 lbs
FR-36	36" Rake	\$80 EA	5 lbs
FR-48	48" Rake	\$88 EA	5 lbs

Dirt Tamp

- Durable all steel construction
- 12" double-dipped vinyl grip handle included

1 Year Limited Warranty

DT-88	8" x 8"	\$88 EA	17 lbs
DT-1010	10" x 10"	\$93 EA	18 lbs



Loop Hoe

- 60" powder coated aluminum handle with 6" non-slip vinyl grip

1 Year Limited Warranty

LH-60		\$45 EA	5 lbs
--------------	--	---------	-------



Sifting Shovel

- Perforated scoop sifts debris from all types of soil
- 42" long handle with 14" x 17" scoop

1 Year Limited Warranty

SS42		\$131 EA	5 lbs
-------------	--	----------	-------

EasyLiner™

EasyLiner™ Field Markers

The preferred line marker for small to large fields.

- 2" or 4" line marking
- Durable 18 gauge steel hopper and frame
- Dual wheel drive for no-slip feed consistency
- Instant on/off gate control

50/100 lb. models include line dispenser viewing window, side mounted storage box, and adjustable fold-in handles for compact storage. Dry line to wet line capable with optional aerosol spray kit (FLMR-AKIT).

3 Year Limited Warranty

FLMR-100HD	100 lb. capacity	\$425 EA	74 lbs
FLMR-50HD	50 lb. capacity	\$365 EA	59 lbs
FLMR-25	25 lb. capacity	\$185 EA	26 lbs



100 lb. capacity
10" no-flat wheels



50 lb. capacity
10" no-flat wheels



25 lb. capacity
8" wheels

Basic and Deluxe Field Marking Packages available. Visit www.Jaypro.com for more information.



10 lb EasyLiner™ Field Marker

200 yard capacity dry liner for touch-ups and small applications.

- 2" line marking
- Durable 18 gauge steel hopper and frame

3 Year Limited Warranty

FLMR-10 \$99 EA 16 lbs

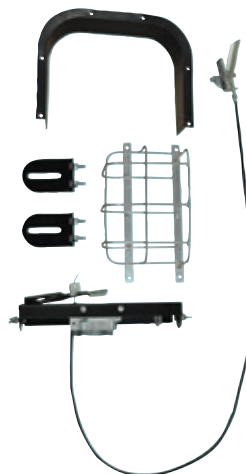

EasyLiner™ Aerosol Spray Kit

Add aerosol spray capability to dry line markers.

- Compatible with 50/100 lb. EasyLiner™ Field Markers
- Basket attaches to liner and holds 2 aerosol cans
- Applicator assembly, brackets, and air deflector included

3 Year Limited Warranty

FLMR-AKIT \$100 KIT 3 lbs



Economy Paint Marker

- 2" to 4" line marking
- Aerosol paint sold separately

3 Year Limited Warranty

FME-501 \$154 EA 28 lbs



Field Marking Wand

- Lightweight single spray can dispenser
- Aerosol paint sold separately

3 Year Limited Warranty

FMWAND \$66 EA 5 lbs



Athletic Field Marking Dust

- Pure white & NCAA compliant
 - Non-toxic & won't stain uniforms
 - Pallet of (50) 50 lb. bags
- Call for freight quote.*



AFMD50 \$445 EA 2,060 lbs



Pro-Stripe Athletic Field Marking Paint

- Concentrate can be diluted with water
- Natural/artificial turf-friendly
- Non-toxic, halogen-free, and won't stain uniforms
- 5 gallon container

FSP-5WT White \$70 EA 52 lbs

FSP-5YW Yellow \$133 EA 52 lbs

Aerosol Paint

Order by case or in bulk!

- Ozone friendly/No CFCs
- Universal spray tip included
- (12) 20 oz. cans per case



GL-101 White \$60 CASE 18 lbs

GL-107 Royal Blue \$74 CASE 18 lbs

GL-108 Yellow \$74 CASE 18 lbs

GL-110 Red \$74 CASE 18 lbs

Aerosol Paint (Bulk)

- Pallet of 50 cases ((12) 20 oz. cans per case)
- Call for freight and bulk pricing.*



PNTPKG-1 White \$2,879 PALLET 1,150 lbs



ProLine Layout & Marking Systems

Quick and economical way to line athletic fields year after year.

- Locators, starting tool, and 600' cord included
- Call for freight quote.*

1 Year Limited Warranty

FM-LM1 12 pc. Baseball \$130 SET 8 lbs

FM-LM2 25 pc. Soccer \$228 SET 10 lbs

FM-LM4 14 pc. Lacrosse \$130 SET 4 lbs

FM-LM5 50 pc. Football \$408 SET 5 lbs

FM-LM0 10 pc. Replacement \$104 SET 2 lbs

Titan™ Adjustable Series

Heavy-duty adjustable steel systems for indoor/outdoor play. A colossal achievement in high performance hoops!

Limited Warranties: System 3 Yr., Net & Pole Pad 1 Yr. 

- Adjustable height of 5½' to 10'
- 2" x 4" heavy gauge steel extension arms
- Tempered glass backboards
- Reliable actuator and safety pin-stop
- Duplex coating "hot dip" galvanized with black powder coat finish
- Breakaway rim or flex goal, nylon net, and stainless steel hardware included
- Black pole padding and backboard edge padding included

Item #	Upright	Offset	Backboard	Weight	Price
CV684A	6" x 8"	4'	42" x 72"	623 lbs	\$1,899 EA
CV664A	6" x 6"	4'	42" x 72"	601 lbs	\$1,699 EA
CV553B	5" x 5"	3'	36" x 60"	477 lbs	\$1,399 EA

TITAN™

ADJUSTABLE SERIES



Clear View Shot Design Technology

Minimizes the distraction of a structure typically located at the center of the backboard.



Lift Assist Technology

Heavy-duty actuator with dual assist springs makes for effortless height adjustment. Crank handle removes to prevent unauthorized adjustment.



Black Edge Padding

Titan™ Replacement Edge Padding

3 Year Limited Warranty

CV684A	42" x 72"	\$179 EA	8 lbs
CV664A	36" x 60"	\$179 EA	8 lbs

Surface Mount Anchor Kit

- Kit includes template, J-bolts, rebar, and hardware

3 Year Limited Warranty

CV553B-AF-GJ	5" x 5"	\$250 EA	30 lbs
CV664A-AF-GJ	6" x 6" and 6" x 8"	\$250 EA	30 lbs



Tempered Glass

Titan™ Replacement Backboard

3 Year Limited Warranty 

GBCV-72	42" x 72"	\$799 EA	245 lbs
GBCV-60	36" x 60"	\$699 EA	163 lbs



Breakaway Goal with Nylon Net

Titan™ Replacement Goal

Limited Warranties: Goal 3 Yr., Net 1 Yr.

GBR360	6" x 8" / 6" x 6"	\$220 EA	24 lbs
GBR361	5" x 5"	\$205 EA	22 lbs



Replacement Post and Gusset Padding

- 2" thick square black post and gusset padding
- Attaches with hook-and-loop closure
- Available in multiple sizes

1 Year Limited Warranty

PP-68	6" x 8"	\$219 EA	3 lbs
PP-66	6" x 6"	\$219 EA	3 lbs
PP-55	5" x 5"	\$187 EA	3 lbs
PP-44	4" x 4"	\$185 EA	3 lbs

TITAN™



770-AC-UG



660-AC-UG

Titan™

Heavy-duty fixed height system with backboard and goal mounted directly to extension arm for exceptional strength. Reinforced with rear support braces!

- Unit buries 48" into ground
- 6" square steel upright with angled extension arm
- Height can be adjusted after court resurfacing
- Acrylic, steel, or perforated steel backboard options
- Galvanized or black powder coat finish models
- Heavy-duty goal and nylon net included
- Optional replacement edge padding (MBBP-6) sold separately
- Backboard - 72"W x 42"H

Limited Warranties: System 3 Yr., Net 1 Yr.



Galvanized Post

660-AC-UG	Acrylic Backboard	\$2,549 EA	500 lbs
660-RS-UG	Steel Backboard	\$2,549 EA	520 lbs
660-PF-UG	Perforated Steel Backboard	\$2,549 EA	500 lbs

Black Powder Coated Post

770-AC-UG	Acrylic Backboard	\$2,695 EA	500 lbs
770-RS-UG	Steel Backboard	\$2,695 EA	520 lbs
770-PF-UG	Perforated Steel Backboard	\$2,695 EA	500 lbs

Acrylic



Steel

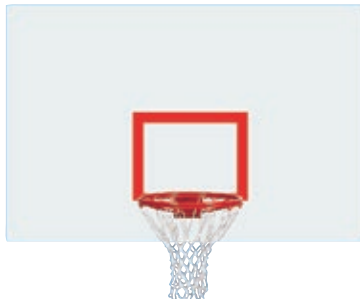

Perforated Steel





The Playground

Durable fixed height system with black powder coat finish and acrylic or steel backboards. 66" extension arm for "play safe" area!

- Unit buries 48" into ground
- 6" square steel upright with angled extension arm
- Height can be adjusted after court resurfacing
- Flex goal (GBA-548), net (JNY-6HP), post and backboard edge padding (EP-46)* included
- Backboards - 72"W x 42"H

*Steel backboard does not include edge padding.

Limited Warranties: Sys. 3 Yr., Goal 7 Yr., Net 1 Yr.



LS-200	Acrylic	\$2,340 EA	474 lbs
LS-200RS	Steel	\$2,308 EA	550 lbs
LD-200	Double Acrylic	\$4,074 EA	766 lbs



The Church Yard

Durable fixed height system with black powder coat finish and acrylic or aluminum fan backboard. 40" extension arm for "play safe" area!

- Unit buries 48" into ground
- 4" square steel upright with angled extension arm
- Height can be adjusted after court resurfacing
- Flex goal (GBA-548), net (JNY-6HP), post (PP-44) and backboard edge padding* (EP-48) included
- Acrylic Backboard - 48"W x 36"H
- Aluminum Fan Backboard - 54"W x 36"H

*Aluminum fan backboard does not include edge padding.

Limited Warranties: Sys. 3 Yr., Goal 7 Yr., Net & Pole Pad 1 Yr.



400-AC-FG	Acrylic	\$1,568 EA	350 lbs
400-FA-FG	Aluminum Fan	\$1,508 EA	300 lbs



H-Frame Design:

The H-Frame design is to be used on systems where gooseneck mounts near the center of the backboard, not at the rim, but above it.



Direct Mount Design:

The Direct Mount design is to be used on systems where both backboard and rim are mounted directly to gooseneck.

HOOP REJUVENATOR™

Hoop Rejuvenator™ Kit

Hoop Rejuvenator™ allows for easy upgrading of existing systems without the added cost of excavating and replacing them.

- Plumbs backboards on leaning goosenecks
- Allows for goal height adjustment after court resurfacing (up to 6" for H-frames and 5" for direct mount units)
- Designed to fit standard mount plates and gooseneck systems 4½" OD and up
- Acrylic, rectangular steel, and aluminum fan backboard options
- H-frame kit and direct mount kit models
- Breakaway goal (UBG-500F), stainless steel hardware, and zinc galvanizing spray to cover rust spots included

3½" OD goosenecks only use aluminum fan backboard (HRKIT-FA).

	Item #	Backboard	Weight	Price
H-Frame	HRKIT-AC	72" x 42" Acrylic	215 lbs	\$1,657 EA
	HRKIT-FA	54" x 36" Alum. Fan	119 lbs	\$1,314 EA
	HRKIT-RC	72" x 42" Steel	206 lbs	\$1,593 EA
Direct Mount	HRKIT-AC-DIR	72" x 42" Acrylic	190 lbs	\$1,444 EA
	HRKIT-FA-DIR	54" x 36" Alum. Fan	101 lbs	\$1,165 EA
	HRKIT-RC-DIR	72" x 42" Steel	185 lbs	\$1,444 EA

* Hardware, Backboard & Goal: 3 Year Limited Warranty, Net: 1 Year Limited Warranty





3½” Gooseneck System

Direct mount style system with backboard and goal mounted directly to extension arm for exceptional strength. 36” extension arm for “play safe” area!

- 3½” zinc undercoated steel upright
- Galvanized or powder coat finish option
- Aluminum fan backboard (ALB-24BT) , goal (GB-55) , and nylon net (JNY-4HP) included
- Backboard - 54”W x 36”H

Limited Warranties



455-FABT-SR-BK	Black	\$1,137 EA	144 lbs
455-FABT-SR-RB	Royal Blue	\$1,137 EA	144 lbs
455-FABT-SR-FG	Forest Green	\$1,137 EA	144 lbs
455-FABT-SR	Galvanized	\$1,022 EA	144 lbs

* System: 3 Year Limited Warranty, Net: 1 Year Limited Warranty

POWDER COAT COLORS



Ultimate Adjustable Gooseneck

A complete adjustable gooseneck system with the benefits of a Hoop Rejuvenator™ Kit.

- 4½” OD heavy-walled galvanized steel post
- H-frame style with 48” extension for “play safe” area
- Acrylic, rectangular steel and aluminum fan backboard options
- Breakaway goal (UBG-500F), and Hoop Rejuvenator™ Kit included

* Limited Warranties



UAG-AC	72” x 42” Acrylic Board	\$2,448 EA	370 lbs
UAG-FA	54” x 36” Aluminum Fan Board	\$2,120 EA	520 lbs
UAG-RC	72” x 42” Steel Board	\$2,448 EA	520 lbs

* Gooseneck, Hardware, Backboard & Goal: 3 Year Limited Warranty, Net: 1 Year Limited Warranty



Shown with optional post padding (PPP-500HP)

GOOSENECK SYSTEMS



	Flex Rim GBR361	Double Rim GDR-54	Playground Goal UBG-500	Breakaway Playground UBG-500F
4½" Diameter Gooseneck Post 4' Offset				
Aluminum Fan ALB-24BT	996-FABT-SG 277 lbs \$1,365 EA	996-FABT-DR 279 lbs \$1,370 EA	996-FABT-UG 288 lbs \$1,416 EA	996-FABT-UB 290 lbs \$1,542 EA
Steel 850RB-BB	996-RS-SG 361 lbs \$1,594 EA	996-RS-DR 363 lbs \$1,599 EA	996-RS-UG 372 lbs \$1,650 EA	996-RS-UB 374 lbs \$1,753 EA
Perforated Steel SR-PERF	996-PERF-SG 391 lbs \$1,787 EA	996-PERF-DR 393 lbs \$1,793 EA	996-PERF-UG 402 lbs \$1,862 EA	996-PERF-UB 404 lbs \$1,940 EA
Perforated Alum. AL-PERF	996-ALP-SG 341 lbs \$1,799 EA	996-ALP-DR 343 lbs \$1,805 EA	996-ALP-UG 352 lbs \$1,816 EA	996-ALP-UB 354 lbs \$1,954 EA
Acrylic ACRB-72	996-AC-SG 366 lbs \$1,747 EA	996-AC-DR 369 lbs \$1,753 EA	996-AC-UG 377 lbs \$1,770 EA	996-AC-UB 379 lbs \$1,845 EA
5½" Diameter Gooseneck Post 6' Offset				
Aluminum Fan ALB-24BT	656-FABT-SG 357 lbs \$2,033 EA	656-FABT-DR 359 lbs \$2,037 EA	656-FABT-UG 368 lbs \$2,056 EA	656-FABT-UB 370 lbs \$2,199 EA
Steel 850RB-BB	656-RS-SG 447 lbs \$2,387 EA	656-RS-DR 443 lbs \$2,393 EA	656-RS-UG 454 lbs \$2,297 EA	656-RS-UB 441 lbs \$2,450 EA
Perforated Steel SR-PERF	656-PERF-SG 471 lbs \$2,519 EA	656-PERF-DR 473 lbs \$2,524 EA	656-PERF-UG 482 lbs \$2,597 EA	656-PERF-UB 484 lbs \$2,677 EA
Perforated Alum. AL-PERF	656-ALP-SG 421 lbs \$2,530 EA	656-ALP-DR 423 lbs \$2,536 EA	656-ALP-UG 432 lbs \$2,614 EA	656-ALP-UB 434 lbs \$2,690 EA
Acrylic ACRB-72	656-AC-SG 446 lbs \$2,482 EA	656-AC-DR 448 lbs \$2,488 EA	656-AC-UG 457 lbs \$2,516 EA	656-AC-UB 459 lbs \$2,516 EA

* Limited Warranties













* Post, Board and Goal: 3 Year Limited Warranty, Net: 1 Year Limited Warranty

Dealer Rated BEST In Customer Service ★★★★★

JAYPRO.COM 800-243-0533

STRAIGHT POST SYSTEMS



4 1/2" Diameter Straight Post 4' Offset		Super Goal GBSG-50	Double Rim GDR-54	Playground Goal UBG-500	Breakaway Playground UBG-500F			
Aluminum Fan ALB-24BT 	SPA4-FABT-SG	322 lbs \$1,493 EA	SPA4-FABT-DR	324 lbs \$1,484 EA	SPA4-FABT-UG	333 lbs \$1,522 EA	SPA4-FABT-UB	335 lbs \$1,528 EA
Steel 850RB-BB 	SPA4-RS-SG	406 lbs \$1,777 EA	SPA4-RS-DR	408 lbs \$1,770 EA	SPA4-RS-UG	417 lbs \$1,808 EA	SPA4-RS-UB	419 lbs \$1,839 EA
Perforated Steel SR-PERF 	SPA4-PERF-SG	436 lbs \$1,845 EA	SPA4-PERF-DR	438 lbs \$1,839 EA	SPA4-PERF-UG	447 lbs \$1,874 EA	SPA4-PERF-UB	449 lbs \$1,882 EA
Perforated Alum. AL-PERF 	SPA4-ALP-SG	386 lbs \$1,993 EA	SPA4-ALP-DR	388 lbs \$1,985 EA	SPA4-ALP-UG	397 lbs \$2,024 EA	SPA4-ALP-UB	399 lbs \$2,030 EA
Acrylic ACRB-72 	SPA4-AC-SG	411 lbs \$1,937 EA	SPA4-AC-DR	413 lbs \$1,684 EA	SPA4-AC-UG	422 lbs \$1,967 EA	SPA4-AC-UB	424 lbs \$1,913 EA
5 9/16" Diameter Straight Post 6' Offset		Super Goal GBSG-50	Double Rim GDR-54	Playground Goal UBG-500	Breakaway Playground UBG-500F			
Aluminum Fan ALB-24BT 	SPA6-FABT-SG	402 lbs \$1,922 EA	SPA6-FABT-DR	404 lbs \$1,928 EA	SPA6-FABT-UG	413 lbs \$2,010 EA	SPA6-FABT-UB	415 lbs \$2,090 EA
Steel 850RB-BB 	SPA6-RS-SG	451 lbs \$2,277 EA	SPA6-RS-DR	453 lbs \$2,282 EA	SPA6-RS-UG	462 lbs \$2,260 EA	SPA6-RS-UB	464 lbs \$2,339 EA
Perforated Steel SR-PERF 	SPA6-PERF-SG	481 lbs \$2,408 EA	SPA6-PERF-DR	483 lbs \$2,414 EA	SPA6-PERF-UG	492 lbs \$2,488 EA	SPA6-PERF-UB	494 lbs \$2,570 EA
Perforated Alum. AL-PERF 	SPA6-ALP-SG	431 lbs \$2,420 EA	SPA6-ALP-DR	433 lbs \$2,427 EA	SPA6-ALP-UG	442 lbs \$2,499 EA	SPA6-ALP-UB	444 lbs \$2,580 EA
Acrylic ACRB-72 	SPA6-AC-SG	456 lbs \$2,373 EA	SPA6-AC-DR	458 lbs \$2,379 EA	SPA6-AC-UG	467 lbs \$2,453 EA	SPA6-AC-UB	469 lbs \$2,453 EA

* Limited Warranties



* Post, Board and Goal: 3 Year Limited Warranty, Net: 1 Year Limited Warranty

Dealer Rated BEST In Customer Service ★★★★★

JAYPRO.COM

800-243-0533



Unbreakable Replacement Package

- 42" Unbreakable Glass Backboard (GBRUB-42)
 - Collegiate "Revolution" Goal (GBA-642)
 - Indoor use only
 - Safe-Pro™ Edge Padding (MBBP-6)
- Specify edge padding color when ordering.*

BBRP-42

Unbreakable Replacement Package

\$999 PKG

218 lbs

GCBP-35PKG

Glass Conversion Package

\$1,095 PKG

252 lbs

* Edge Padding: 10 Year Limited Warranty, Backboard: 3 Year Limited Warranty, Goal: 7 Year Limited Warranty, Net: 1 Year Limited Warranty



new

Glass Conversion Package

- 42" Rectangular Glass Conversion Backboard (GCBP-35)
 - Collegiate "Revolution" Goal (GBA-642)
 - Indoor use only
 - Safe-Pro™ Edge Padding (MBBP-6)
- Specify edge padding color when ordering.*

EDGE PAD COLORS

- Pink
- Cardinal
- Burnt Orange
- Purple
- Old Gold
- Royal Blue
- Scarlet Red
- Navy Blue
- Yellow
- Forest Green
- Orange
- Maroon
- Kelly Green
- Black
- Columbia Blue
- Gray
- Light Purple



Unbreakable Rectangular Glass Backboard

½" thick tempered glass backboard designed for impact load on goal to transfer directly to a lower reinforced steel frame member without putting stress on glass. Indoor use only.

- Direct mount (4" x 5" hole pattern) or 4 corner mounting
- High strength clear anodized aluminum frame
- Pre-drilled for Safe-Pro™ Edge Padding (MBBP-6)
- Goal and net sold separately



GBRUB-42 72" x 42" Unbreakable Glass Backboard

\$850 EA 179 lbs

GBRUB-54 54" x 42" Unbreakable Glass Backboard

\$759 EA 160 lbs

Note: The glass itself is not unbreakable. Breakage in transit, during mounting, malicious acts, or deliberate attempts to damage are not covered under warranty. Boards used with height adjusters below 10' are not covered under warranty.

3 Year Limited Warranty



48" Rectangular Glass Backboard

Similar features to the Unbreakable Glass Rectangular Backboard. Indoor use only.

- Direct mount (5" x 5" hole pattern) or 4 corner mounting
- Goal and net sold separately



GBAFR-48 72" x 48" Rectangular Glass Backboard

\$899 EA 200 lbs



42" Rectangular Glass Conversion Backboard

½" thick tempered glass backboard easily converts fan-shaped backboards to rectangular backboard. Eliminates need to alter playing court or backstop system. Indoor use only.

- Direct mount (4" x 5" hole pattern) or 4 corner mounting (20" x 35")
- High strength clear anodized aluminum frame
- Goal and net sold separately



3 Year Limited Warranty



GCBP-35 72" x 42" Backboard

\$850 EA 213 lbs

Patented Perforated Polycarbonate Backboard

Shatterproof backboard is 250x stronger and 30% lighter than conventional glass backboards. Retrofits most indoor/outdoor support structures! Will require mounting hardware specific to the existing pole/system. Indoor use only.

- 1/2" thick polycarbonate backboard with perforated holes
 - Graffiti, UVF, and scratch resistant coating
 - Goal, edge padding, and net sold separately
- Specify trim color when ordering. Call for freight quote.*

TRIM COLORS



1 Year Limited Warranty 

3654CB	54" x 36" Backboard	\$1,882 EA	75 lbs
4272CB	72" x 42" Backboard	\$2,585 EA	130 lbs
4872CB	72" x 48" Backboard	\$2,611 EA	150 lbs



42" Rectangular Acrylic Backboard

- 5" x 5" goal mounting pattern
- Border and target included
- Goal and net sold separately
- Outdoor use only
- 72"W x 42"H

3 Year Limited Warranty 

ACRB-72	\$924 EA	145 lbs
----------------	-----------------	---------



36" Rectangular Acrylic Backboard

- 5" x 5" goal mounting pattern
- Border and target included
- Goal and net sold separately
- Outdoor use only
- 48"W x 36"H

3 Year Limited Warranty 

LS-44AB	\$616 EA	99 lbs
----------------	-----------------	--------

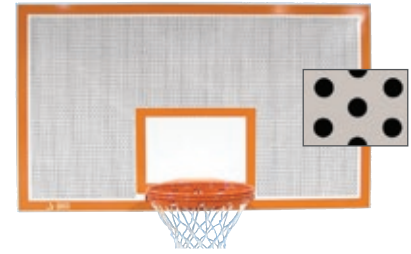

42" Rectangular Perforated Steel Backboard

- 5" x 5" goal mounting pattern
- Rear support frame allows for multiple mounting conversions
- 11 gauge steel face with 1/4" dia. perforations
- Goal and net sold separately
- Outdoor use only
- 72"W x 42"H

3 Year Limited Warranty 

SR-PERF	\$891 EA	133 lbs
----------------	-----------------	---------



42" Rectangular Steel Backboard

- 5" x 5" goal mounting pattern
- 12 gauge steel with rear welded mounting pattern (35" x 20")
- Goal and net sold separately
- Outdoor use only
- 72"W x 42"H

3 Year Limited Warranty 

Backboard w/ Border & Target		
850RB-BB-BT	\$907 EA	200 lbs
Backboard w/ Target		
850RB-BB	\$907 EA	200 lbs



42" Rectangular Perforated Aluminum Backboard

- 5" x 5" goal mounting pattern
- Rear support frame allows for multiple mounting conversions
- Aluminum face with 1/4" dia. perforations
- Goal and net sold separately
- Outdoor use only
- 72"W x 42"H

3 Year Limited Warranty 

AL-PERF	\$922 EA	86 lbs
----------------	-----------------	--------



36" Aluminum Fan Backboard

- 5" x 5" goal mounting pattern
- Cast aluminum with 1 1/2" flange
- Goal and net sold separately
- Outdoor use only
- 56"W x 36"H

3 Year Limited Warranty 

ALB-24BT	\$499 EA	60 lbs
-----------------	-----------------	--------

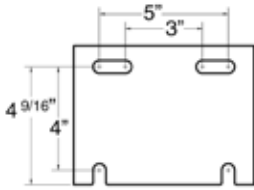

Mounting Plate
(GBA-642, GBA-542)

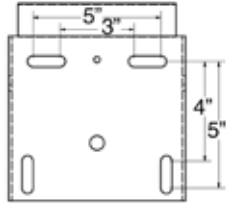

Mounting Plate
(GBA-648, GBA-548)



“Revolution” Breakaway Goal

Adjustable breakaway goal with excellent rebound consistency.

- Hideaway net attachment system
- 5” x 5” or 5” x 4” mounting hole pattern (GBA-648)
- 5” x 4” mounting hole pattern (GBA-642)
- Anti-whip net and mounting hardware included

Check existing hole pattern for correct placement.

NCAA
COMPLIANT

NFHS
COMPLIANT

FIBA
COMPLIANT

* Limited Warranties

GBA-642	42” Backboard	\$289 EA	24 lbs
GBA-648	42” & 48” Backboard	\$289 EA	25 lbs

“Shot” Breakaway Goal

Adjustable breakaway goal with excellent rebound consistency.

- Pigtail ring net attachment system
- 5” x 5” or 5” x 4” mounting hole pattern (GBA-548)
- 5” x 4” mounting hole pattern (GBA-542)
- Anti-whip net and mounting hardware included

Check existing hole pattern for correct placement.

NCAA
COMPLIANT

NFHS
COMPLIANT

FIBA
COMPLIANT

* Limited Warranties

GBA-542	42” Backboard	\$279 EA	24 lbs
GBA-548	42” & 48” Backboard	\$279 EA	24 lbs

* Goal: 7 Year Limited Warranty, Net: 1 Year Limited Warranty

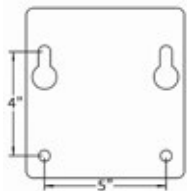

Mounting Plate
(GBA-18042)

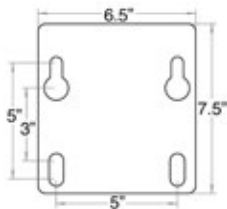

Mounting Plate
(GBA-180)

Competitor 180° Breakaway Goal

Adjustable positive lock releasing goal is made to break from any angle.

- Excellent rebound consistency
- Hideaway net attachment system
- 5” x 5” mounting hole pattern (GBA-180)
- 5” x 4” mounting hole pattern (GBA-18042)
- Nylon net and mounting hardware included

NCAA
COMPLIANT

NFHS
COMPLIANT

FIBA
COMPLIANT

* Limited Warranties

GBA-18042	42” Backboard	\$485 EA	19 lbs
GBA-180	48” Backboard	\$440 EA	19 lbs

* Goal: 3 Year Limited Warranty, Net: 1 Year Limited Warranty

Competitor Adjustable Breakaway Goal

Adjustable goal withstands different levels of pressure.

- Pigtail ring net attachment system
- 5" x 4" goal mounting pattern
- Nylon net and mounting hardware included



* Limited Warranties

GBA-342A 42" Backboard \$269 EA 23 lbs

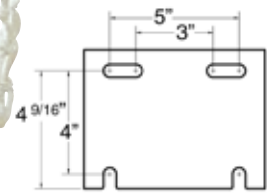
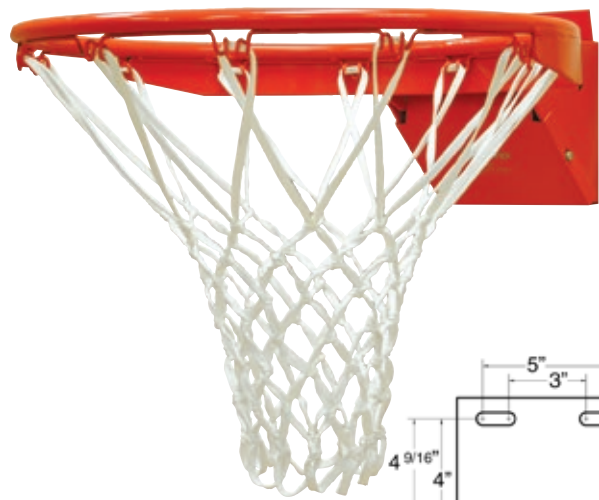

Mounting Plate

Competitor Pro Adjustable Breakaway Goal



Adjustable goal withstands different levels of pressure.

- Pro level hideaway net attachment system
- 5" x 4" goal mounting pattern
- Nylon net and mounting hardware included



* Limited Warranties

GBA-600 42" Backboard \$275 EA 24 lbs

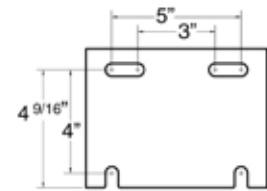
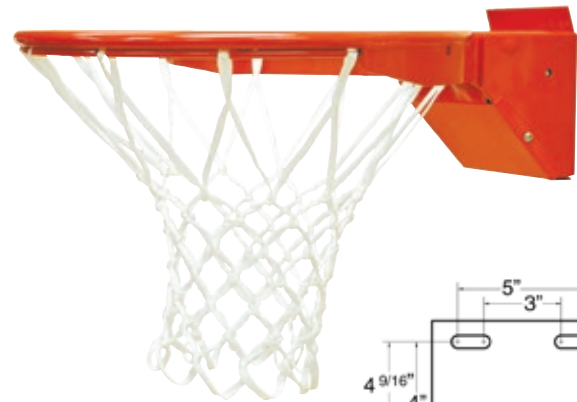

Mounting Plate

Breakaway Goal

Adjustable goal withstands different levels of pressure.

- Indoor/outdoor heavy-duty use
- Pigtail ring net attachment system
- Three spring mechanism
- Fits 5"x 5" or 5"x 4" mounting hole pattern
- Nylon net and mounting hardware included



* Limited Warranties

GBR360 42" & 48" Backboard \$220 EA 24 lbs

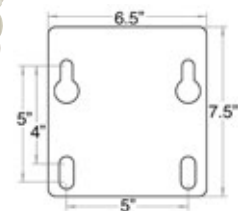

Mounting Plate

* Goal: 3 Year Limited Warranty, Net: 1 Year Limited Warranty

Single Rim Goal

- Official size 18" ring with universal hole pattern - indoor/outdoor
- Nylon net and zinc plated mounting hardware included

* Limited Warranties

GB-55 \$82 EA 15 lbs

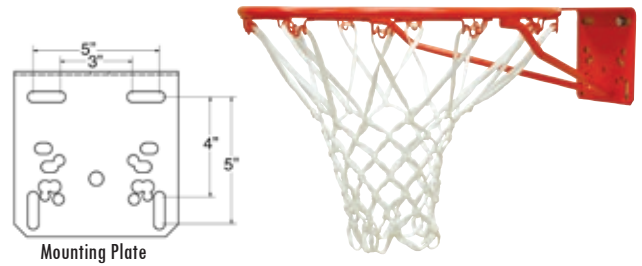

Super Goal

- Indoor/outdoor
- Official size high-strength rim with universal hole pattern
- Nylon net and zinc plated mounting hardware included

* Limited Warranties

GBSG-50 \$130 EA 17 lbs

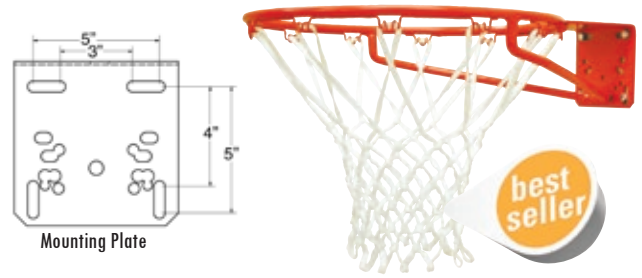

Double Rim Goal

- Official size 18" double ring with universal hole pattern - outdoor
- Nylon net and zinc plated mounting hardware included

* Limited Warranties

GDR-54 \$132 EA 19 lbs

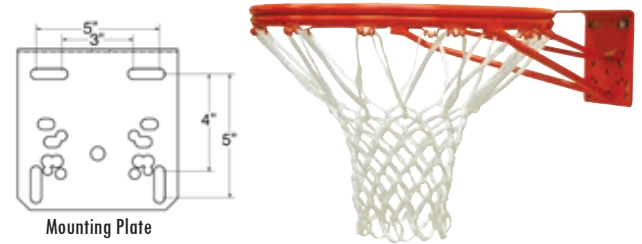

Flex Goal

- Outdoor light-duty use
- Pigtail ring net attachment system
- Two spring mechanism
- Fits 5" x 5" or 5" x 4" mounting hole pattern
- Nylon net and mounting hardware included

* Limited Warranties

GBR361 \$205 EA 22 lbs

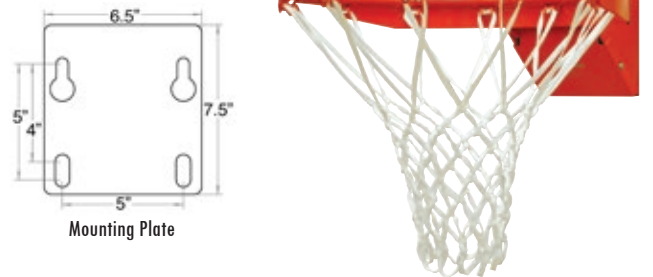

Playground Goal

- Fixed double steel rim with no-fail net lock system and universal hole pattern - outdoor
- Nylon net included (can be used with a chain net)

* Limited Warranties

UBG-500 \$185 EA 23 lbs

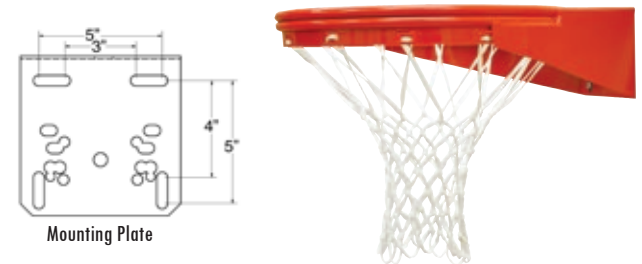

Playground Breakaway Goal

- Indoor/outdoor goal with universal hole pattern
- Nylon net included (can be used with a chain net)

* Limited Warranties

UBG-500F \$247 EA 32 lbs

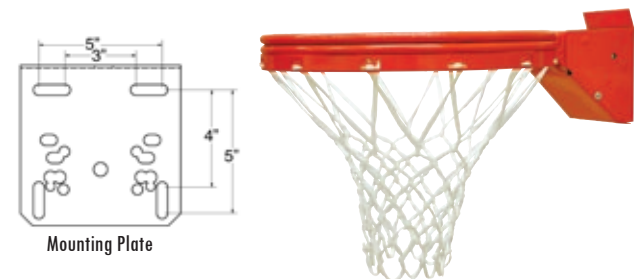

* Goal: 3 Year Limited Warranty, Net: 1 Year Limited Warranty



Shooters Ring

- Creates smaller diameter rim (16") for practice
- Attaches to standard basketball goals
- Requires no tools for easy install

3 Year Limited Warranty

SHOTRING \$30 EA 5 lbs



Rebound Ring

- Develops rebounding skills
- Keeps balls from falling through rim (10" inside diameter)
- Attaches to 18" goal with 3 screws

3 Year Limited Warranty

RBRING \$31 EA 3 lbs



Hideaway Rim Steel Replacement Ring

- Fits Jaypro models: Revolution Breakaway Goal (GBA-642/GBA-648) and Competitor Pro Adjustable Breakaway Goal (GBA-600)
- Slide through brackets to attach net

3 Year Limited Warranty

BBSR-R \$14 EA 1 lb

Removable Goal Bracket Kit

Stop theft, potential damage and unwanted play!

- Fits most front mount backboards with 5" x 5" mounting pattern
- Bracket, hardware and padlock included

Recommended for GB-55, GBSG-50, or GDR-54 goals. Not to be used with breakaway goals.

3 Year Limited Warranty

GAK-5 \$70 EA 5 lbs

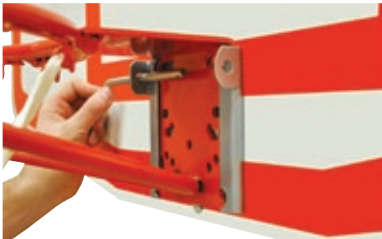

Mount the GAK-5 bracket to your backboard and be able to slide your rim on and off. It can also be locked in place.



Nylon Net

- 12 loop net
- 680/32 braided

1 Year Limited Warranty

JNY-4HP \$8 EA 1 lb



Anti-Whip Nylon Net

- 120 threaded 12 loop net
- Braided cord stops from flipping onto rim

1 Year Limited Warranty

JNY-6HP \$14 EA 1 lb



Standard Chain Net

- Fits any style goal
- Heavy-duty "S" hooks

3 Year Limited Warranty

J-3 \$33 EA 2 lbs

Safe-Pro™

Safe-Pro™ Edge Padding

- Bolts easily to all 72" official glass backboards
- Pin style attachment eliminates pad sagging under rim

NCAA
COMPLIANT

NFHS
COMPLIANT

FIBA
COMPLIANT

10 Year Limited Warranty

MBBP-6XX \$165 EA 15 lbs

MBBP-6PK	Pink	MBBP-6FG	Forest Green
MBBP-6C	Cardinal Red	MBBP-6OR	Orange
MBBP-6TO	Burnt Orange	MBBP-6M	Maroon
MBBP-6P	Purple	MBBP-6KG	Kelly Green
MBBP-6OG	Old Gold	MBBP-6BK	Black
MBBP-6RB	Royal Blue	MBBP-6CB	Columbia Blue
MBBP-6S	Scarlet Red	MBBP-6GY	Gray
MBBP-6NB	Navy Blue	MBBP-6LP	Light Purple
MBBP-6YW	Yellow		

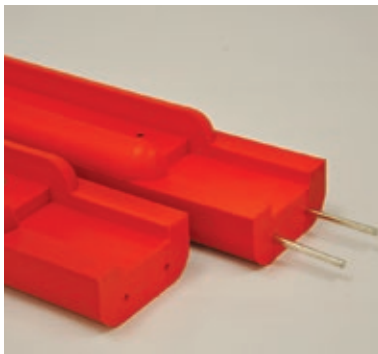

Bolt-on edge padding includes two steel connectors for perfect alignment



EDGE PAD COLORS



Safe-Pro™ 54" Bolt-On Edge Padding

Bolts easily to all 54" glass backboards.

10 Year Limited Warranty

MBBP-54S	Scarlet Red	\$185 EA	16 lbs
MBBP-54GY	Gray	\$165 EA	16 lbs
MBBP-54BK	Black	\$165 EA	16 lbs
MBBP-54RB	Royal Blue	\$185 EA	16 lbs



1½" Bolt-On Edge Padding

"L" shape molded padding for 48" indoor/outdoor wood or acrylic backboards.

3 Year Limited Warranty

EP-48 Black \$199 EA 7 lbs

"L" shape molded padding for 72" indoor/outdoor wood or acrylic backboards.

EP-46 Black \$199 EA 12 lbs

"U" shape molded padding for 72" indoor/outdoor wood backboards.

MBBP-WB Gray \$225 EA 15 lbs



Basketball Post Padding

- 30" wide padding with 4" thick high-density foam
 - 14 oz. vinyl cover with grommet flaps for rear lacing
 - Lacing cord included
 - 30"W x 6'H (fits 4½" posts)
- Specify vinyl color when ordering. Custom graphics not available with this product.*

1 Year Limited Warranty 

PPP-5HP \$269 EA 9 lbs



Pro Style Protector Pad

- 6' tall pad with 6" thick cylindrical high-density foam
 - 14 oz. nylon reinforced vinyl cover with hook-and-loop closure
 - Available sizes to fit 4½" and 5⅝" posts
- Specify vinyl color when ordering. Custom graphics sold separately.*

1 Year Limited Warranty  

PPP-500HP	4½" OD Pole
\$477 EA	18 lbs
PPP-700HP	5⅝" OD Pole
\$573 EA	20 lbs

PAD COLORS



Custom Graphics for Basketball Post Padding

Customize basketball post pads with single or multi-color graphics.

JSG-BPP2
Multi-color custom graphic per pad.

Contact customer service for artwork requirements and pricing. Extended lead time may apply.

See page 120 for more details.





Little Champ™ Easy Adjust Backboard Adapter

Ideal for youth leagues and elementary schools to develop shooting skills.

- Complete details and more information on page 121

3 Year Limited Warranty

LC-6HP	\$800 EA	49 lbs
LC-6	\$1,488 PR	98 lbs



Frame folds down and rim folds up for compact storage



Little Champ™ 8.5 Backboard Adapter



- Complete details and more information on page 121

3 Year Limited Warranty

LC-2HP	\$590 EA	38 lbs
LC-2	\$1,100 PR	76 lbs

Little Champ™ Classic Backboard Adapter



- Complete details and more information on page 121

3 Year Limited Warranty

LC-1HP	\$510 EA	46 lbs
LC-1	\$870 PR	80 lbs



Possession Indicator

- Red LED indicator lights with toggle switch operation
- 15' long AC adapter included
- 20" x 5" x 2"

1 Year Limited Warranty

POSIND1	\$159 EA	3 lbs
----------------	----------	-------



LED Backboard Light Kit

- Backboard lights up when shot clock or game time reaches zero
- Specify manufacturer/model when ordering. Interfaces with most shot clocks. Call for freight quote.*

1 Year Limited Warranty

BB-LED42	CALL FOR PRICING	25 lbs
-----------------	------------------	--------



Basketball Court Stencil

Easily paint a regulation basketball court on a driveway, patio or play area.

- Precision cut stencils
- Paint roller included
- 13'L x 21'W

1 Year Limited Warranty

BCS-1	\$49 EA	5 lbs
--------------	---------	-------



Hack Attack Pitching Machines

3 wheel advantage design provides accuracy and speed with no wear. Emulates a live pitcher with speeds of 35-100 mph (35-70 mph - high school junior machine) and a distance of 43'. Fastballs, risers, drops, right and left handed screwballs, pop-ups, fly balls, and grounders.

5 Year Limited Warranty 

HABPM-100	Baseball	\$3,299 EA	195 lbs
HASPM-200	Softball	\$3,299 EA	135 lbs
HABPM-100JR	Baseball Junior	\$2,199 EA	96 lbs
HASPM-200JR	Softball Junior	\$2,199 EA	75 lbs



Blast Attack Pitching Machine

Portable pitching machine for club and youth programs. Emulates a live pitcher and delivers fastballs up to 70 mph.

5 Year Limited Warranty

BAPM-1		\$1,299 EA	115 lbs
---------------	--	------------	---------

Call for FREIGHT quotes for all products on this page

Snap Attack Football Machine

Releases passes and punts up to 100 yards, 70+ yards for kick-offs, and 5-15 yards for snap tight spirals. 70+ mph speeds!



5 Year Limited Warranty 

SAFM-1		\$3,999 EA	165 lbs
---------------	--	------------	---------



Attack Volleyball Machines

Wheel propelled for increased performance. Maximize daily practice drills with repeatable reps for serve receive, sets, digs, and spikes. Sharp topspins, breaking floaters, and more!

* Limited Warranties 

Attack Volleyball Machine

For men's games. Spike speeds up to 80+ mph with ball release point of 6' to 9'3".

VBSA-1		\$3,299 EA	200 lbs
---------------	--	------------	---------

Attack II Volleyball Machine

For women's games. Spike speeds up to 70 mph with ball release point of 5'6" to 8'6".

VBSA-2		\$2,999 EA	200 lbs
VBSA-BAG	Replacement Bag	\$139 EA	10 lbs

Skill Attack Volleyball Machine

For club/youth programs. Spike speeds up to 40 mph with ball release point of 5'3".

VBSA-3		\$1,299 EA	55 lbs
---------------	--	------------	--------

* Machine: 5 Year Limited Warranty, Bag: 1 Year Limited Warranty

Custom Colors - Configurations - Features - Installations



Call For Freight Quotes - For integration with current audio/visual systems.

SCOREBOARDS

Baseball Scoreboard

Features 0-99 scoring and 0-9 inning. 14" and 16" indicators. Protective digit lens kit included.

Scoreboard Colors: Black, Navy, Royal, Purple, Burgundy, Red, Forest Green
Light Colors: Amber, Green or White

Specify scoreboard color and light color when ordering. Call for freight quote.

BSB86 5'H x 8'W \$3,700 EA 220 lbs



Multi-Sport Scoreboard

Features 0-199 scoring, 1/10th second timing, built-in horn, and time of day clock. 14", 12", 10" and 2" indicators. Protective digit lens kit included.

Scoreboard Colors: Black, Navy, Royal, Purple, Burgundy, Red, Forest Green
Light Colors: Amber, Green or White

Specify scoreboard color and light color when ordering. Call for freight quote.

BKS81 3'H x 8'W \$3,080 EA 230 lbs



Multi-Sport Scoreboard 2

Features: 0-199 scoring, 1/10th second timing, built-in horn, time of day clock, and multi-sport capabilities (Volleyball, Wrestling and Basketball). 14", 12", 10" and 2" indicators. Protective digit lens kit included.

Scoreboard Colors: Black, Navy, Royal, Purple, Burgundy, Red, Forest Green
Light Colors: Amber, Green or White

Specify scoreboard color and light color when ordering. Call for freight quote.

BKS82 5'H x 8'W \$4,107 EA 250 lbs



Football Scoreboard

0-99 Scoring, quarter, down and to go. 16" and 3" indicators. Protective digit lens kit included. Horn sold separately.

Scoreboard Colors: Black, Navy, Royal, Purple, Burgundy, Red, Forest Green
Light Colors: Amber, Green or White

Specify scoreboard color and light color when ordering. Call for freight quote.

FBS45 6'H x 14'W \$5,395 EA 320 lbs



Soccer/Lacrosse Scoreboard

Multi-sport capabilities (Lacrosse, Field Hockey). 16", 14" and 2" indicators. Protective digit lens kit included.

Scoreboard Colors: Black, Navy, Royal, Purple, Burgundy, Red, Forest Green
Light Colors: Amber, Green or White

Specify scoreboard color and light color when ordering. Call for freight quote.

SCS82 4'H x 8'W \$3,309 EA 176 lbs



5 Year Limited Warranty for all items on this page

Dealer Rated BEST In Customer Service ★★★★★

JAYPRO.COM 800-243-0533

100

Wireless Console, Case & Slip Sheets

new

Durable aluminum enclosure with rubber molded ends.

- High visibility amber LED display with intuitive screen layouts
- Built-in 2.4GHz radio (wireless system) with 1600 ft. range
- Built-in rechargeable lithium-ion battery with 10 hours run time and charge % indicator
- Removable sport specific keypad templates allow use for any sport, stat panels, and timers
- Traditional alpha keyboard allows for programming electronic message center functions
- Operates single or multiple scoreboards with no pre-set wireless channels
- Simple set-up menu allows for adjusting scoreboard brightness and all game parameters



5 Year Limited Warranty

Call for freight quote

MSC00

5"H x 10¼"W x 9"D

\$915 EA

12 lbs

Trumpet Horn Kit (125 dB)

new

Used for outdoor scoreboards (see football and soccer/lacrosse models). *Additional add on for outdoor boards. Request if needed.*



5 Year Limited Warranty

Call for freight quote

DTHORN

\$345 EA

15 lbs

Shot and Play Clock

- 0-99 shot clock/timer
 - Counts up & down
 - Built-in horn
 - Comes in black
 - Digits are 14"
 - Dimensions: 2'H x 2'W
- Call for freight quote.



1 Year Limited Warranty

BKS29

\$2,566 PR

70 lbs



LED Backboard Light Kit

- Backboard lights up when shot clock or game time reaches zero
- Specify manufacturer/model when ordering. Interfaces with most shot clocks. Call for freight quote.*

1 Year Limited Warranty

BB-LED42

CALL FOR PRICING

25 lbs



Digital display control panel on back for operator



Tabletop Scoreboard

Rear control panel with visual display. LED lights score up to 199 and timer up/down to 99:59. Automatic/manual buzzer. 110v power with 15' power cord. 16" x 24" x 10"

3 Year Limited Warranty

TTS10

\$993 EA

12 lbs

Shot Clock Mounting Bracket

For Jaypro Elite Portable Systems. Shot clock not included.

3 Year Limited Warranty

PBEL-SCBEA

\$430 EA

30 lbs



Possession Indicator

LED display with toggle switch operation and AC adapter. 20" x 5" x 2"

3 Year Limited Warranty

POSIND1

\$159 EA

3 lbs

ELITE 9600

Meets NCAA & NFHS Rules for Portable Competition



All Elite Series portables feature a spring assisted mechanism allowing easy operation and goal height adjustments. Each portable includes non-marking heavy-duty casters to easily transport, and easy set-up with adjustable front feet to level each unit.

Additional features include:

- Adjustable 8' - 10' goal height with pin stops every 6"
- Durable white powder coat finish
- Ballast weight included

Call for freight quote.

* Limited Warranties: System 3 Yr., Net & Pad 1 Yr.



Item	Board Extension	Rear Ballast Weight	Rear Anchor Kit	Weight	Price
ELITE 9600 PBEL96	8'	1,000 lbs	Included	2,600 lbs	\$9,859 EA
ELITE 6600 PBEL66	5' 6"	800 lbs	Sold Separately	2,400 lbs	\$8,599 EA
ELITE 5400 PBEL54 (54" Board)	4' 6"	800 lbs	Sold Separately	1,600 lbs	\$6,855 EA
ELITE 5400 PBEL5472 (72" Board)	4' 6"	800 lbs	Sold Separately	1,600 lbs	\$7,645 EA

Dim	ELITE 9600	ELITE 6600	ELITE 5472	
	PBEL96	PBEL66	PBEL54	PBEL5472
A	81"	80 3/4"	79 1/4"	79 1/4"
B	153 1/4"	123 1/4"	110 3/4"	110 3/4"
C	45"	15"	3 3/4"	3 3/4"
D	108 1/4"	108 1/4"	107"	107"
E	30 1/4"	30 1/4"	46"	46"

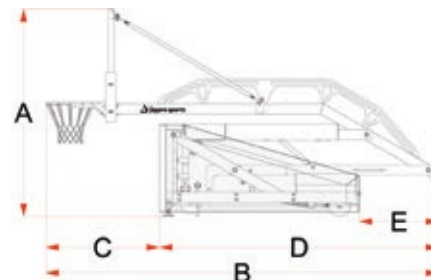

Rear Anchor Kit

Includes all hardware to attach to built-in rear eye bolt on portable systems.

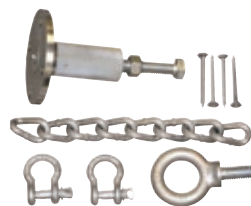

3 Year Limited Warranty

PBELKIT-100	For floating wood floors	\$259 EA	3 lbs
PBELKIT-89	For other type floors	\$259 EA	3 lbs

All ELITE Series Portables Include:



Rectangular Glass Backboard with Direct Goal Mounting



GBA-642 Adjustable Breakaway Goal



2" thick Vinyl Wrapping Padding



MBBP-6 Bolt-on Safety Edge Padding



Ballast Weight



ELITE 6600

ELITE 5400

Available with either 54" or 72" backboard.

SHIPPING NOTICE
Flatbed tow truck, forklift or loading dock required to unload our portable indoor systems.

* Limited Warranties: System 3 Yr., Net & Pad 1 Yr.



Visit JAYPROSPECS.COM for product specifications

Portable Basketball System

- Adjusts 6'6" to 10' - no tools required
- 48" extension arm for "play safe" area
- 48" x 32" acrylic backboard and breakaway goal
- Backboard edge padding (EP-48) and rear anchor kit sold separately
- Customer supplied ballast required is 300-350 lbs.
- Portable system vinyl padding included
- Some assembly required

Call for freight quote.

WARNING! Failure to install customer supplied ballast according to instruction provided could result in serious injury.

* Limited Warranties: System 3 Yr., Net & Pad 1 Yr.

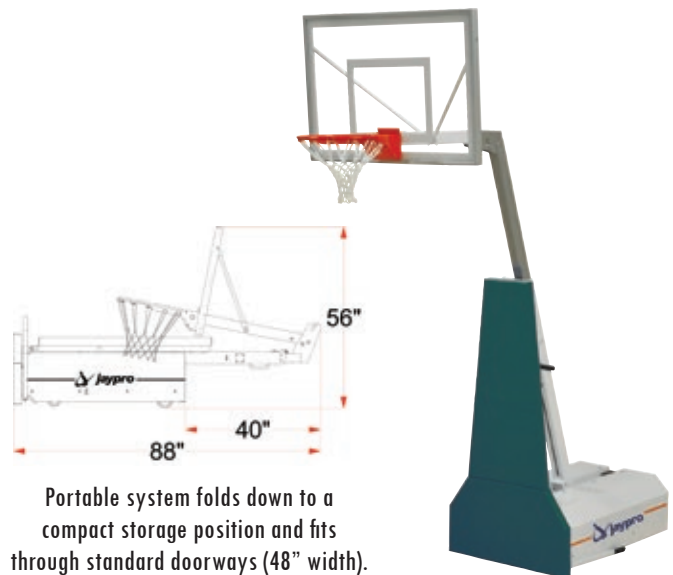

Portable system folds down to a compact storage position and fits through standard doorways (48" width).

PBB-200	System	\$3,445 EA	430 lbs
EP-48	Edge Padding (Black)	\$199 EA	7 lbs
AB-4832	48" x 32" Backboard	\$474 EA	40 lbs

JAYPRO.COM

800-243-0533

Glass Board Wall-Mounted Backstops

- Available in Stationary, Fold-Up, or Side-Folding applications - Includes 42" Glass Board (GBRUB-42), Breakaway Goal (GBA-642), 1.90" OD heavy-duty black powder coated frame and wood stringers
- Fold-Up Systems operated with manual or electric winch (sold separately)
- Side-Fold Systems include manual pull-pin to lock unit in either playing or storage position
- Direct goal mounted to eliminate any strain on the board
- Requires cutting and drilling in the field to achieve desired extension off wall
- Refer to spec sheets for additional information, dimensional requirements, and structural requirements
- Wall anchors specified and supplied by installer

Visit JAYPROSPECS.COM for product specifications

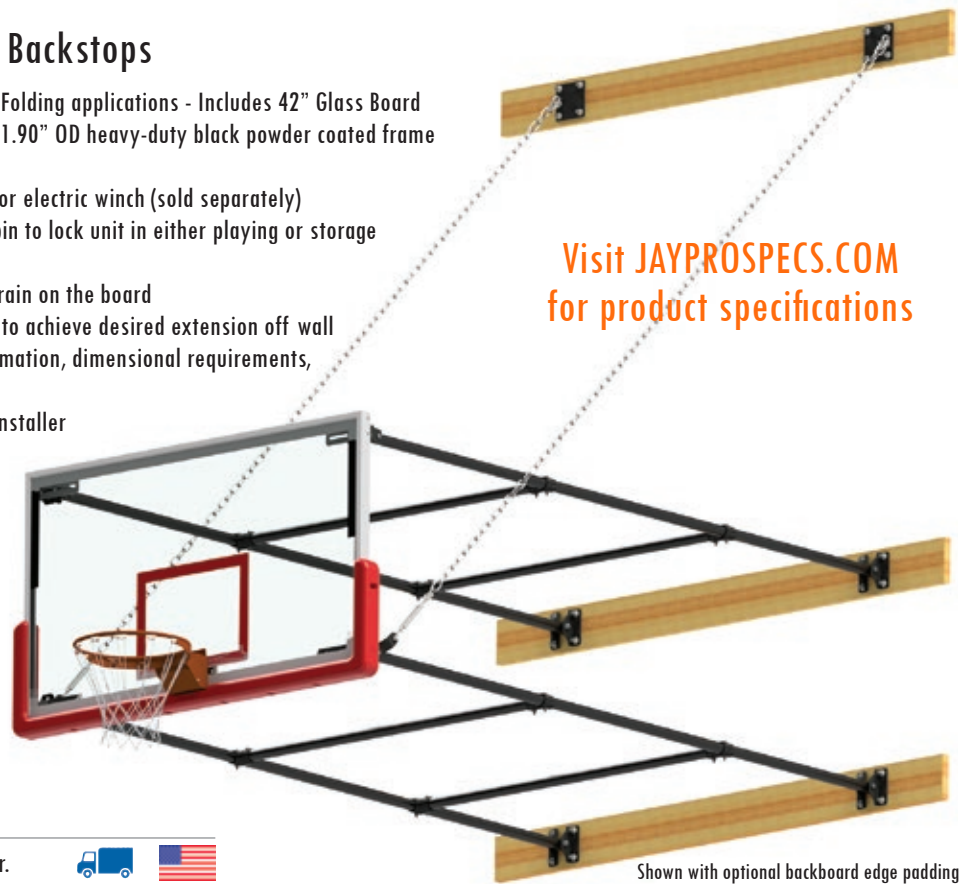

Shown with optional backboard edge padding

Wall-Mounted Backstops Options:

- Manual or electric height adjuster
- Backboard edge padding (page 96)
- Wall anchors (page 109)

* Limited Warranties: System 3 Yr., Net 1 Yr.



Stationary Backstop System			
Face of Bank	Item	Weight	Price
2'- 4'	N24GB	350 lbs	\$2,260
4'- 6'	N46GB	398 lbs	\$2,527
6'- 8'	N68GB	417 lbs	\$2,659
8'- 10'	N810GB	466 lbs	\$3,059
10'- 12'	N1012GB	485 lbs	\$3,131

Fold-Up Backstop System *			
Face of Bank	Item	Weight	Price
4'- 6'	U46GB	450 lbs	\$3,131
6'- 8'	U68GB	469 lbs	\$3,188
8'- 10'	U810GB	518 lbs	\$3,593
10'- 12'	U1012GB	537 lbs	\$3,664

* Manual or electric winch and safety strap sold separately

Side-Fold Backstop System			
Face of Bank	Item	Weight	Price
4'- 6'	S46GB	440 lbs	\$2,664
6'- 8'	S68GB	459 lbs	\$2,659
8'- 10'	S810GB	499 lbs	\$2,927
10'- 12'	S1012GB	518 lbs	\$2,997

8'-10' Height Adjuster Kits for Wall-Mounted Backstops

- Kit includes height adjuster, board mounts, and hardware required to install on Stationary, Fold-Up, or Side-Fold Backstop Systems
- Choose between manual or electric height adjuster operation
- Various methods of operation available (page 108)
- Electric height adjusters may be hard wired or temporarily powered off a standard 120 volt electrical wall outlet

3 Year Limited Warranty



Height Adjuster	Method of Operation	Item	Weight	Price
Manual	Sold Separately	AHA-WM	180 lbs	\$1,343
Electric	Key Switch, Included	EHA-WM-KS	212 lbs	\$2,674
Electric	Power Wand, Sold Separately	EHA-WM-PW	216 lbs	\$2,530
Electric	Other, Sold Separately	EHA-WM	211 lbs	\$2,576



Wall-Mounted Backstop with Manual Height Adjuster

IMPORTANT NOTES FOR WALL-MOUNTED BACKSTOPS AND SHOOTING STATIONS: Wall-mounted backstop systems should only be installed on walls capable of supporting the weight of the equipment plus the additional weight of a player hanging on the rim. Consult an architect, structural engineer or contractor if necessary. Jaypro Sports bears no responsibility for the structural integrity of the wall the backstop is mounted on.

3-Point Stationary Fan Board Wall-Mounted Shooting Station

- Economy stationary wall-mounted shooting station includes 36" Aluminum Fan Board (ALB-24BT), Breakaway Goal (GBA-548), 1.90" OD heavy-duty frame and wood stringers
- Direct goal mounted to eliminate any strain on the board
- Requires cutting and drilling in the field to achieve desired extension off wall
- Wall anchors specified and supplied by installer

Face of Bank	Item	Weight	Price
6" - 2'	N2FB	264 lbs	\$1,468
2' - 3½'	N236FB	280 lbs	\$1,585
3' - 6½'	N366FB	359 lbs	\$1,976
6' - 8'	N68FB	371 lbs	\$2,237
8' - 10'	N810FB	412 lbs	\$2,499

* Limited Warranties: System 3 Yr., Net 1 Yr.

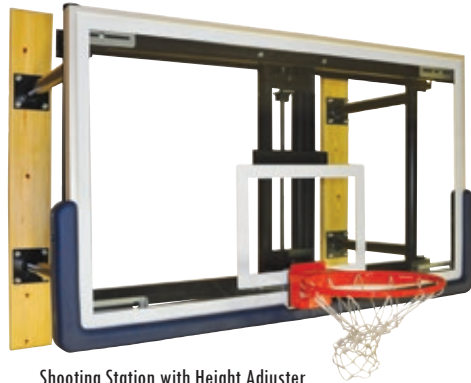
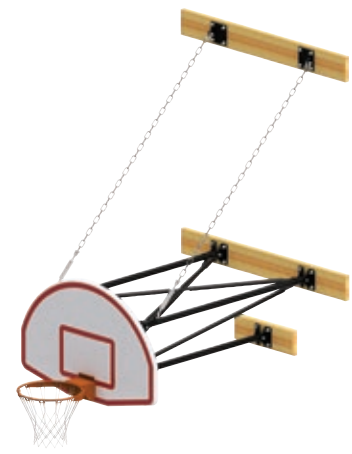

Shooting Station with Height Adjuster
(Edge Padding sold separately)

Glass Board Wall-Mounted Shooting Station

- Wall-mounted shooting station includes 42" Glass Backboard (GBRUB-42), Breakaway Goal (GBA-642), 2⅜" OD heavy-duty welded frame and wood stringers
- 3' Face of bank
- Available with or without 8' - 10' manual height adjuster (HA-1H handle included)
- Wall anchors specified and supplied by installer

* Limited Warranties:
System 3 Yr., Net 1 Yr.



Description	Item	Weight	Price
Station w/ Height Adjuster	WMWH	440 lbs	\$3,105
Station w/o Height Adjuster	WMSS	285 lbs	\$2,217

Indoor/Outdoor Adjustable Wall-Mounted Shooting Station

- Wall-mounted shooting station includes glass or acrylic backboard, flex goal, heavy-duty steel frame, and black edge padding (glass boards only)
- Rim height manually adjustable from 7'-6" to 10' with integral hand crank
- 33" - 44" extension off wall depending on height of rim
- Wall anchors specified and supplied by installer

* Limited Warranties:
System 3 Yr., Net 1 Yr.



Board Size	Board Type	Item	Weight	Price
36" x 48" x ½"	Acrylic	WM-48	250 lbs	\$1,300
36" x 60" x ½"	Glass w/ Edge Padding	WM-65	300 lbs	\$1,468
36" x 54" x ½"	Glass w/ Edge Padding	WM-54	255 lbs	\$1,500
36" x 60" x ½"	Acrylic	WM-60	300 lbs	\$1,424



Black Edge Padding included with
Glass Boards only



Column Mounted Fan Board Shooting Station

- Designed to mount directly to exposed vertical or tapered column
- Shooting station includes 36" Aluminum Fan Board, Breakaway Goal (GBA-548), and structure to attach
- Available with or without 8' - 10' manual height adjuster (HA-1H handle included)
- Refer to spec sheet for column dimension requirements and additional information

* Limited Warranties:
System 3 Yr., Net 1 Yr.



Description	Item	Weight	Price
Station w/ Height Adjuster	CMWH	200 lbs	\$2,030
Station w/o Height Adjuster	CMSS	142 lbs	\$1,342

IMPORTANT NOTES FOR WALL-MOUNTED BACKSTOPS AND SHOOTING STATIONS: Wall-mounted backstop systems should only be installed on walls capable of supporting the weight of the equipment plus the additional weight of a player hanging on the rim. Consult an architect, structural engineer or contractor if necessary. Jaypro Sports bears no responsibility for the structural integrity of the wall the backstop is mounted on.

Direct Drive Electric Backstop Winch

- Raise & lower wall-mounted or 32' and under ceiling suspended backstops
- Universal mounting allows easy installation for new or existing conditions
- 1 HP 115 volt single phase motor
- Maintenance free operation with no belts or chains to replace
- Various methods of operation to choose from (page 108)

TW-2000-1	Winch only	\$1,297 EA	67 lbs
TW-2000	Winch with Key Switch	\$1,392 EA	70 lbs

Wall Mounting Kit for Direct Drive Backstop Winch

- Kit includes winch, key switch, mounting boards & hardware
- Wall anchors specified and supplied by installer

TW-2000KT1	Winch with Wall Mounting Kit	\$1,395 EA	85 lbs
-------------------	------------------------------	------------	--------



Electric Winch with Wood Kit

1 Year Limited Warranty

Manual Backstop Winch

- Raise & lower wall-mounted or 27' and under ceiling suspended backstops
- Maintenance free operation with no belts or chains to replace
- Various methods of operation to choose from

TW-700M	Winch only	\$675 EA	34 lbs
TW700H	Manual Winch Handle	\$299 EA	10 lbs

Wall Mounting Kit for Manual Backstop Winch

- Kit includes winch, mounting boards & hardware
- Wall anchors specified and supplied by installer

TW-700MKT1	Manual Winch with Wall Mounting Kit	\$818 EA	75 lbs
-------------------	-------------------------------------	----------	--------

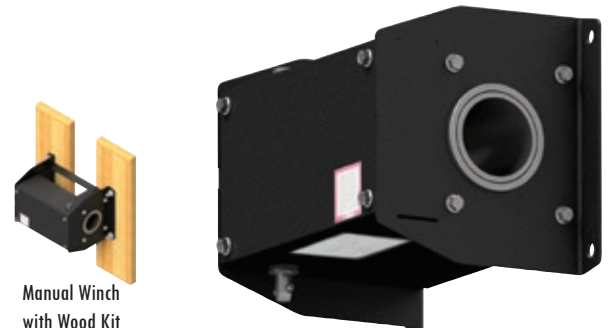

Manual Winch with Wood Kit

1 Year Limited Warranty



Manual Winch Drill Operator

1 Year Limited Warranty

ED-902	\$799 EA	19 lbs
---------------	----------	--------

Posilok™ Backstop Safety Strap

- Locks wall-mounted or ceiling suspended backstop in position should a failure or malfunction occur
- Indicator to notify when the safety strap has been called into action
- Safety belt capable of withstanding 7,300 lb load
- Universal mounting allows easy installation for new or existing conditions

PL-1000	\$568 EA	22 lbs
----------------	----------	--------

Wall Mounting Kit for Backstop Safety Strap

- Kit includes safety strap, mounting boards & hardware
- Wall anchors specified and supplied by installer

PL-1000KT1	\$865 EA	28 lbs
-------------------	----------	--------

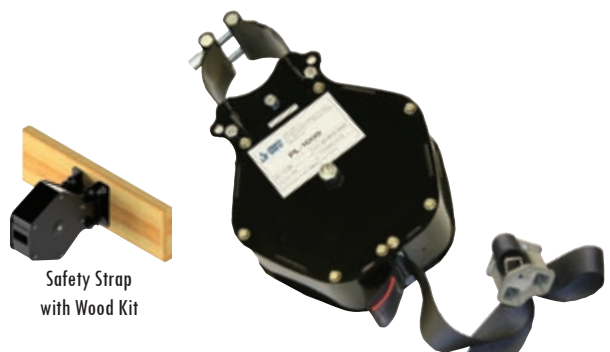

Safety Strap with Wood Kit

1 Year Limited Warranty

Direct Drive Electric Curtain Winch

- Raise & lower motorized divider curtains with 2 3/8" OD drive pipe
- Universal mounting allows easy installation for new or existing conditions
- Integral Posilok™ over-speed arrest system to lock the curtain into position should a malfunction occur
- 1 HP 115 volt single phase motor
- Maintenance free operation with no belts or chains to replace
- Various methods of operation to choose from (page 108)

CW-1800-1	Winch only	\$1,625 EA	82 lbs
CW-1800	Winch with Key Switch	\$1,695 EA	81 lbs



1 Year Limited Warranty

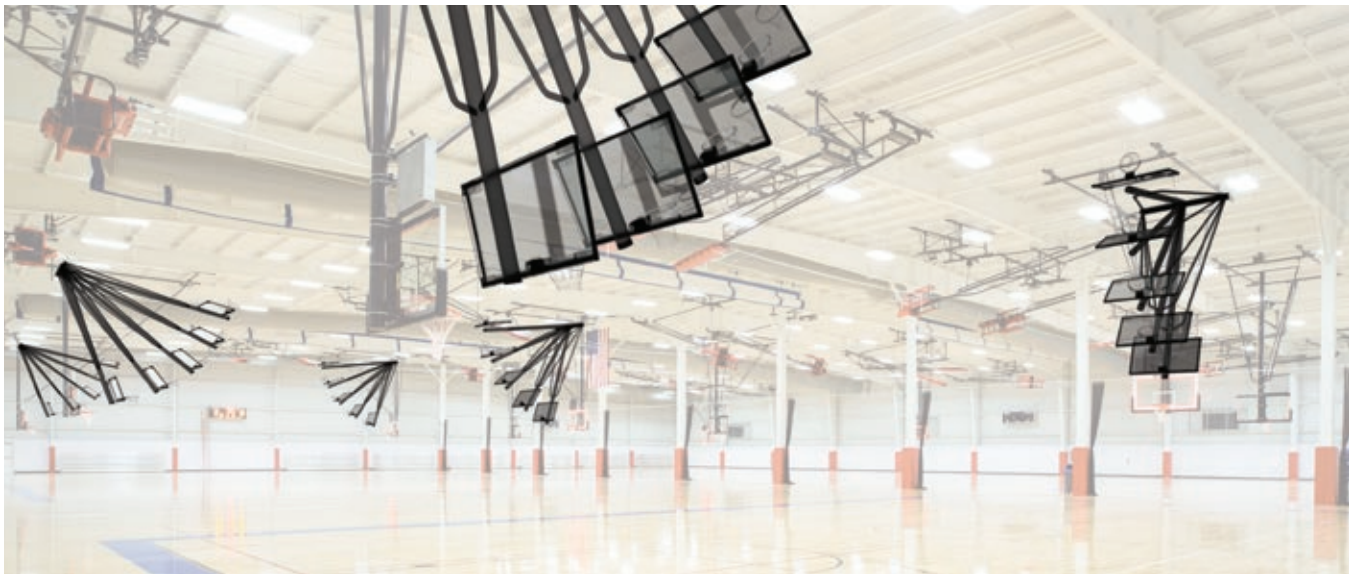

Master Equipment Controller 2 (MEC2)

Similar to your touchscreen smartphone, this slick wall-mounted touchscreen is one of the best upgrades for any facility. The MEC2 features intuitive menus to allow anyone to easily program at any point in time, without switches or removal of the screen. Simply put, the MEC2 is the leading economical equipment control system in the industry!

- Low voltage 7" capacitive touchscreen
- Individual or grouped simultaneous operation
- Easily expandable with low cost expansion relay boards
- Protected with multiple tiered access logins
- Simple retrofit from existing methods of operation
- Direct replacement for MEC-99 control system
- Refer to the MEC2 spec sheet for additional information



MEC2 Call for Pricing

Easy Touch Equipment Controller (ETEC)

With all the same benefits as the MEC2, the ETEC features additional unparalleled benefits, making this system the ultimate gymnasium equipment controller in the industry. The ETEC allows you to simultaneously raise your divider curtains and side court backstops, while lowering your main court backstops. The ETEC is truly a must-have control system for large facilities with quick turn-around time.

- Low voltage 10.4" high resolution LCD touchscreen
- Simultaneous up and down operation
- On-the-fly quick selection programming
- Customized facility layouts with intuitive graphical interface
- Instantly saves user programs with the press of a button
- Refer to the ETEC spec sheet for additional information

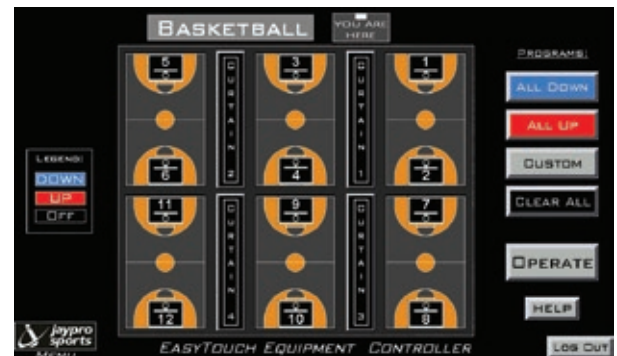

ETEC Call for Pricing

Methods of Operation

Key Switch



KS-13 Key Switch \$95 EA
GPWKS-XX Ganged Key Switches Call for Pricing

Ganged Key Switches



Radio Remote Receiver



DRX-1199 Radio Remote Receiver \$462 EA
TMX-1199 Radio Remote Transmitter \$251 EA

Radio Remote Transmitter



Height Adjuster Kits for Ceiling Suspended Backstops

Take the guess work out of how to add a height adjuster to an existing ceiling suspended backstop. Kits fit the most common backstop frames and include 42" glass board (GBRUB-42), breakaway goal (GBA-642), manual or electric height adjuster, board mounts and hardware. Edge padding sold separately.

Center Strut Backstops

- Mounts to 6" or 6 5/8" OD backstop structure

3 Year Limited Warranty



Center Strut Backstop with Electric Height Adjuster

Double Drop Backstops

- Mounts to 2 3/8" OD backstop frame structure
- Mounting holes drilled in field to fit almost any frame width

3 Year Limited Warranty



Double Drop Backstop with Electric Height Adjuster

Height Adjuster	Method of Operation	Center Strut Backstops			Double Drop Backstops		
		Item	Weight	Price	Item	Weight	Price
Manual	Sold Separately	GBCS-AHA	330 lbs	\$1,999	GBDD-AHA	400 lbs	\$2,200
Electric	Key Switch, Included	GBCS-EHAKS	345 lbs	\$3,467	GBDD-EHAKS	415 lbs	\$3,570
Electric	Power Wand, Sold Separately	GBCS-EHAPW	350 lbs	\$3,574	GBDD-EHAPW	420 lbs	\$3,677
Electric	Other, Sold Separately	GBCS-EHA	330 lbs	\$3,075	GBDD-EHA	400 lbs	\$3,168

Visit JAYPROSPECS.COM for product specifications

Height Adjuster Operators:

3 Year Limited Warranty

- | | | | |
|-------------|--|----------|--------|
| A) HA-1H | Manual Height Adjuster Hand Crank | \$110 EA | 9 lbs |
| B) CD-80H | Manual Height Adjuster Cordless Operator | \$867 EA | 16 lbs |
| C) KS-13 | Momentary Electric Key Switch | \$95 EA | 1 lb |
| D) HAPW-100 | Electric Height Adjuster Power Wand Controller | \$550 EA | 5 lbs |

Multiple Control Systems available, page 107



CD-80H



HA-1H



HAPW-100



Hoist Pulley Fitting

Mounts to 3½" OD pipe, rated for 1,550 lbs

CA35HD-SP-A

\$191 EA 8 lbs



Wall Pulley Fitting

Mounts to structural wall, rated for 1,550 lbs, anchors by others

D-PLATE2-A

\$191 EA 14 lbs



Brace Attachment Fitting

Mounts to 3½" OD pipe, hinge accommodates 2¾" OD pipes

HP35-238A-A

\$125 EA 1 lb



Safe Strap Mast Attachment Fitting

Mounts to 6½" OD masts only

PL658-A

\$96 EA 9 lbs

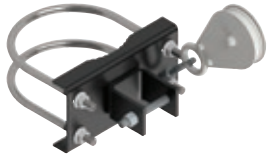

Mast Brace & Pulley Fitting

Mounts to 6½" OD mast, hinge accommodates 2¾" OD pipes

PT65-238-SP-A

\$171 EA 12 lbs



Cable & Safe Strap Retractor System

Retracts cable and safe strap out of playing area

SSR-25

\$133 EA 3 lbs



Cross Over Under Fitting

Connects perpendicular 3½" OD pipes

S35-X-A

\$76 EA 9 lbs



Standard Beam Clamp Fitting

Mounts 3½" OD pipe only, rated for 1 Ton

UDC2-12-A

\$68 EA 6 lbs



Strut Beam Clamp

Rated for 1,000 ea

HM6157

\$16 EA Single Strut 1 lb

HM6159

\$16 EA Double Strut 1 lb



3½" U-Bolt w/ Nuts

For 3½" OD pipe only

HB5040

\$9 EA 1 lb



6½" U-Bolt w/ Nuts

For 6½" OD pipe only

HM6074

\$9 EA 2 lbs



Electrical Quick Disconnect

Winch twist-lock pig tail kit

PT-72

\$164 EA 3 lbs

Backstop Cable Kit

Replacement ¼" lifting cable kit

RC-53 50' \$133 EA 8 lbs

RC-78 75' \$151 EA 11 lbs

RC-100 100' \$171 EA 14 lbs



Backstop Swivel Eye Pulley

¼" cable, rated for 1,550 lbs

HM6077

\$96 EA 3 lbs



Forged Anchor Shackle

¾", galvanized, rated 1 Ton

HM6252

\$37 EA 1 lb



"Double" Dual Expansion Machine Bolt Wall Anchor

For solid concrete walls, including pre-cast concrete or filled block.

HM2711 ½" Expansion Anchor \$10 EA 1 lb

SR5187 ½" Threaded Rod - 12" Long \$14 EA 1 lb

SR5276 ½" Threaded Rod - 18" Long \$14 EA 1 lb



No. 1 Type Tumble Toggle Wall Anchor

For hollow, non-filled CMU walls.

HM6212 \$10 EA 1 lb

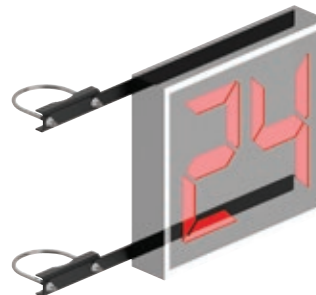

Shot Clock Mounting Brackets (only)

Mount any shot clock to existing backstops

SCMB658-A 6½" OD Mast \$379 PR 30 lbs

SCMB6-A 6" OD Mast \$379 PR 30 lbs

SCMB238-A 2¾" Double Drop \$379 PR 30 lbs

Gym Divider Curtains

Jaypro Sports offers a variety of functional and attractive divider curtains that help divide any sports facility or institutional space. From power-controlled to manual curtains, we custom design divider curtains for any facility size requirements. Also available in solid vinyl or vinyl coated mesh with several color options.

Fold Up Curtain FC-680

The most versatile and robust curtain in the industry. This curtain uses hoist cables which are weaved through grommets and are attached to the bottom batten. Hoist cables simply roll on the driveline, causing the curtain to fold neatly towards the ceiling in an accordion style fashion.

- Most durable, longest lasting curtain in the industry
- Easiest retractable curtain to install
- Compact fold to maximize clear height

Call for freight quote.



Visit JAYPROSPECS.COM for product specifications

Electric Curtain Winch CW-1800



See page 106 for details



Slope Fold Curtain **SC-685**

Engineered to fit against the roof frame and conform to virtually any slope while providing maximum clearance for all sporting activities. This curtain can conform to virtually any roof to maximize clearance for all sporting events. Check out the new Field House Slope Fold Curtain (SC-685XL) on page 112. *Call for freight quote.*

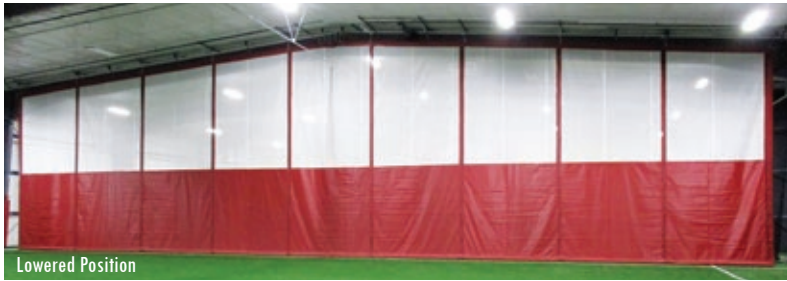

Top Roll Curtain **TC-701**

Uses no hoist cables or straps to raise and lower the curtain and stores tighter than many other curtain designs for additional clearance with low ceilings. When operated, the entire fabric rolls onto the drive pipe. *Call for freight quote.*



Mini Top Roll Curtain **TC-710**

Compact curtain system designed to store tight to the ceiling structure by means of an internal tubular motor. Ideal for cafeterias, meeting rooms, stages, or other small spaces. *Call for freight quote.*



Walk Draw Curtain **WC-660 & WC-660BP**

Designed for manual operation, this curtain is moved by pulling it along a ceiling suspended track to store along a perimeter wall. *Call for freight quote.*

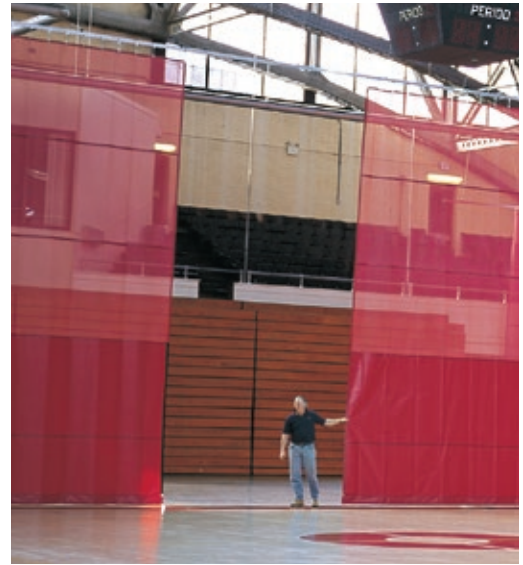

Roll Up Curtain **RC-690**

Raised and lowered by heavy-duty hoist belts and stores in a 2' storage space close to the building structure. When operated, hoist belts roll the fabric onto the bottom batten. *Call for freight quote.*

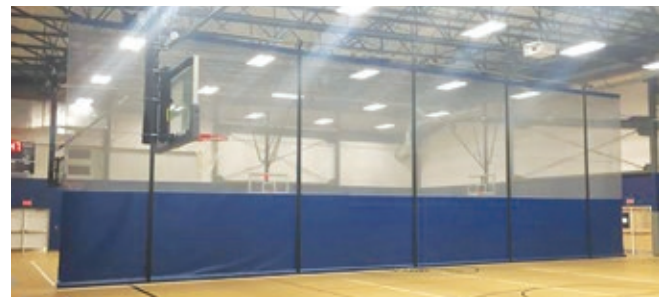

Field House Slope Fold Curtain SC-685XL

Engineered to fit against the roof frame and conform to virtually any slope while providing maximum clearance for all sporting activities. This mega curtain utilizes dual synchronized winches with a low voltage controller. This curtain can conform to virtually any roof to maximize clearance for all sporting events. Pictured below, this SC-685XL curtain measures 190' long and 42' high at the peak and raises to the ceiling in 75 seconds. *Call for freight quote.*

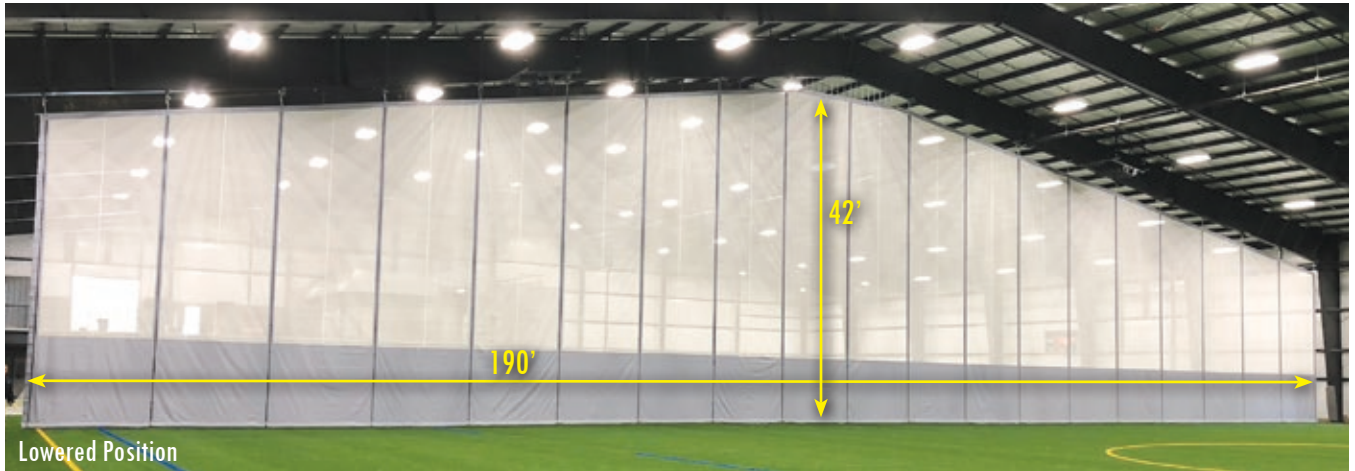

Perimeter Fold Up Curtain FC-680P

Jaypro Perimeter Curtains are ideal for completely following the inside or outside perimeter of running tracks within multi-use facilities and field houses. These curtains are designed to separate the running track from interior basketball or volleyball courts, thereby maximizing facility use and flexibility. Adjoining curtains are overlapped and offset to allow for easy egress. *Call for freight quote.*



Motorized Netting

Safety netting systems are designed to protect spectators or create safe passageways outside the field of play. A complete surround netting system can be used to seal off a court or field for ball containment. Netting can enclose the perimeter of a facility as well as create a ceiling. Netting systems can be motorized or stationary. Contact Jaypro's estimating department to help design a solution for your netting needs. *Call for freight quote.*

Visit JAYPROSPECS.COM
for product specifications



Protective Stationary Netting

Jaypro makes nets to separate outdoor athletic fields in large complexes and to divide indoor athletic facilities. We also provide complete perimeter and ceiling netting protection for your athletic facility. Our netting is found on tennis courts, basketball courts, soccer fields, and golf courses. Everything we make is customized to your needs as no two facilities are alike. Call or e-mail us to discuss your project. *Call for freight quote.*

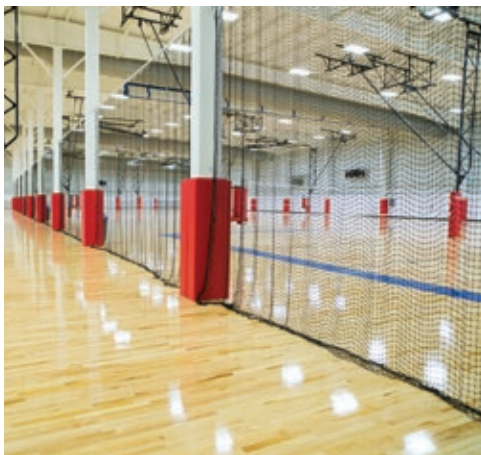

Securelift™ Wrestling Mat Storage Systems

Eliminate risk of injury to students, athletes and coaches from manual lifting and transporting of heavy and awkward mats. Gain valuable storage space and extend the life of your wrestling mats. Simply roll the mat(s) onto the sling, attach the sling to the load bar, turn the key to raise the unit and store at ceiling height. Call for details and pricing.



MH-S-A Single Ceiling Suspended Single Mat Securelift™ Call for Pricing
MHWM-S-A Single Wall-Mounted Single Mat Securelift™ Call for Pricing

3 Year Limited Warranty



MH-D-A Double Ceiling Suspended Double Mat Securelift™ Call for Pricing
MHWM-D-A Double Wall-Mounted Double Mat Securelift™ Call for Pricing

3 Year Limited Warranty



MATLOK™

Matlok™ Wrestling Mat Storage System Safety Strap

- Designed to automatically lock a mat hoist system in position should a malfunction occur
- Self-checking, self-leveling, fail safe mechanism features
- System comprised of 2 load bar rocker assemblies and 4 Posilok™ Safety Straps



- System adaptable to any wrestling mat storage system
- Versatile mounting clamps included

3 Year Limited Warranty

MH-MLS Call for Pricing and Details

Visit JAYPROSPECS.COM
for product specifications

Scorer Table

- Illuminated table (120VAC, 60Hz) comfortably sits 3-4 people
- Tabletop includes multiple cup holders and folds vertically for storage
- Large access holes in tabletop for console, laptop cords or other electronics
- Bins under the table hold extension cords, power adapters and other accessories
- 3" lockable swivel poly wheels
- Removable shatterproof face panels for multiple sponsors or team logos
- Customer provides artwork to go on face panels
- Colors available include Black, Royal Blue, Purple, Dark Green, Maroon, Red or Green (specify when ordering)

Call for freight quote.

3 Year Limited Warranty



Free Standing Style

Item	Length	Weight	Price
ST-8FS	8'	357 lbs	\$4,202 EA
ST-10FS	10'	454 lbs	\$4,471 EA



ST-10FS



ST-8BM

Bleacher Mount Style

Item	Length	Weight	Price
ST-8BM	8'	397 lbs	\$4,707 EA
ST-10BM	10'	637 lbs	\$5,216 EA

CUSTOM WALL PAD GRAPHICS

Wall Pad Graphics

Customize your gymnasium with your team logo or school graphics.
Contact customer service for Custom Graphics and Pricing.





Visit JAYPROSPECS.COM for product specifications



WallGUARD™
Impact Wall Padding

Impact Wall Padding

- 2" thick high impact foam with 7/16" Oriented Strand Board backing
- 14 oz. fire-retardant vinyl in a variety of colors
- Exceeds impact standards as defined in ASTM F2440-04

Call for freight quote.

Item	Size	Description	Weight	Price
JWCF-I-2472	2' x 6'	lip top & bottom	33 lbs	\$143 EA
JWCF-I-2472Z	2' x 6'	z-clip top & lip bottom	34 lbs	\$153 EA
JWCF-I-2472ZZ	2' x 6'	z-clip top & bottom	35 lbs	\$163 EA

Player protection to meet various facility needs and atmospheres.

- Provides excellent wall protection to absorb player impact
- Reduces noise levels in any facility
- Wall padding should be installed on all rigid surfaces located in close proximity (within 10') to active playing areas



WallGUARD™
Fire/Impact Wall Padding

Fire/Impact Wall Padding

- 2" thick fire-retardant and high impact foam with 7/16" Oriented Strand Board backing
- 14 oz. fire-retardant vinyl in a variety of colors
- Exceeds impact standards as defined in ASTM F2440-04
- Certified class A fire rating in accordance with NFPA 255/ASTM E-84

Call for freight quote.

Item	Size	Description	Weight	Price
JWCF-AI-2472	2' x 6'	lip top & bottom	37 lbs	\$225 EA
JWCF-AI-2472Z	2' x 6'	z-clip top & lip bottom	38 lbs	\$235 EA
JWCF-AI-2472ZZ	2' x 6'	z-clip top & bottom	39 lbs	\$246 EA

Mounting options:

Lip top and bottom Z-clip top and lip bottom Z-clip top and bottom



CUSTOM WALL PAD PROJECT? CALL FOR QUOTE!



L-Shaped Corners

Ideal for a setting where any exposed obstruction must be completely covered on all sides.

- Fire retardant vinyl
- High impact foam
- Variety of attachment methods

Specify pad color when ordering. Call for pricing, details and freight quote.



I-Beam Wrap

Protect exposed I-beams.

- Designed to wrap the face and front edges of beam
- Fire retardant vinyl
- High impact foam
- Hook and loop attachment

Specify pad color when ordering. Call for pricing, details and freight quote.

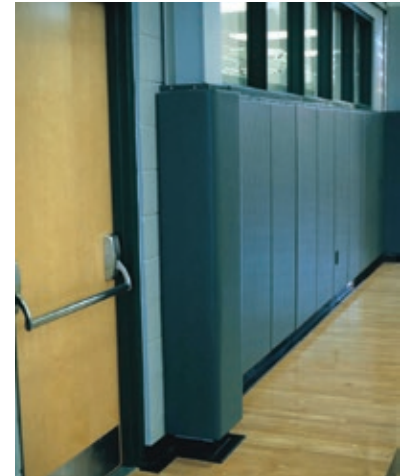

Column Padding

Protect exposed columns commonly found in indoor facilities.

- Fire retardant vinyl
- High impact foam
- Variety of attachment methods

Specify pad color when ordering. Call for pricing, details and freight quote.

Stage Padding

Pads designed specifically for stage applications.

- Folding design permits easy storage access
- Fire retardant vinyl
- High impact foam
- Variety of attachment methods

Specify pad color when ordering. Call for pricing, details and freight quote.



PAD COLORS



Dual Purpose Wall/Tumbling Mat



Serves as wall padding or as a tumbling mats.

- 4' x 6' non-folding mat with 4 handles
- 2" thick vinyl covered foam pad
- 1½" wide hook-and-loop closures on all sides
- See chart for colors (specify when ordering)

1 Year Limited Warranty



GMVH-1

\$388 EA 14 lbs

Hook-and-Loop Closure Wall Hanging Strip



For use with Dual Purpose Wall/Tumbling Mat (GMVH-1).

- 2" wide aluminum strip
- Pressure sensitive 1½" wide hook-and-loop closure securely bonds to aluminum strip for long lasting use
- Only available in 4' sections

1 Year Limited Warranty



VMH-13

\$33 EA 1 lb

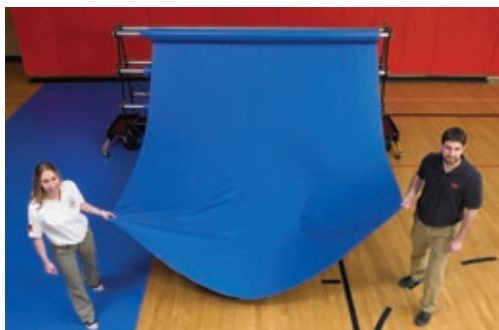

Color options: Tan, Brown/Tan, Royal Blue, Tan/Royal Blue, Light Gray, Red, Green, Burgundy, Tan/Burgundy, Kelly Green, Navy Blue, Dark Gray, Black, Orange and Yellow.

SHIPPING NOTICE
Extended forklift or loading dock required to unload the safety storage racks.

Gym Guard Floor Cover

Protect gymnasium floor during non-athletic events with durable, flame-retardant and fungal resistant fabric.

- Meets Fire Marshall specifications, and ASTM E-84, Class A specs
 - 18, 22, and 27 oz. options
 - 6"-12" overlap recommended
- 10' wide standard size.

18 oz. only available in solid colors. Specify dimensions and fabric color when ordering. Call for freight quote.

1 Year Limited Warranty 

GGFPS-16	18 oz. Floor Cover	\$1.94	SQ FT
GGFPS-22	22 oz. Floor Cover	\$1.94	SQ FT
GGFPS-24	27 oz. Floor Cover	\$1.94	SQ FT

Floor Cover Storage Rack

- All steel construction
 - 8" dia. non-marking wheels lock and swivel
 - 2 hand cranks included
- Call for freight quote.

1 Year Limited Warranty 

MSR-6	6 Roll Rack	\$3,937	EA	621 lbs
MSR-8	8 Roll Rack	\$4,287	EA	641 lbs
MSR-10	10 Roll Rack	\$4,704	EA	711 lbs

Courtclean

Get a safe, clean floor in minutes with this damp mop system.

- 6' mop made of polyethylene material
- Hook-and-loop fasteners keep towel in place
- Replacement towels sold separately

1 Year Limited Warranty



Item	Description	Weight	Price
CCM-6	6' Courtclean Mop	29 lbs	\$664 EA
CCT-6	6' Courtclean Towel	1 lb	\$59 EA
CCSS-1	1 gal. Super Shine-All	10 lbs	\$68 EA
CCSK-6	6' Start Up Kit	20 lbs	\$257 EA



Keyclean Pro

- 2 large 18" x 24" mops made with highly absorbent microfiber pads
- 6' adjustable two-piece aluminum handle
- Fast drying and slip resistant to reduce injuries
- 2 mops and 2 pads included
- Replacement pads available
- Can be customized

1 Year Limited Warranty

Item	Description	Weight	Price
KCP-1	Keyclean Pro Set	10 lbs	\$440 EA
KCPD-2	Keyclean Pro Pads	2 lbs	\$99 EA
KCP-1C	Custom Pro Set	13 lbs	\$599 EA



Note: Due to difference in wall construction, Jaypro Sports does not provide anchors or mounting hardware to attach the wall stringers to gymnasium walls. Consult your architect or contractor to determine the best and safest installation methods for your facility.

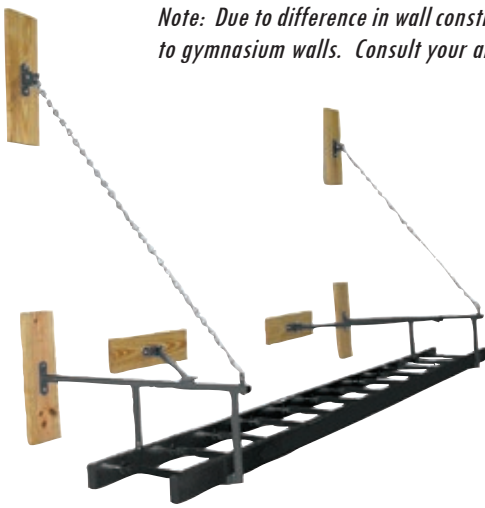

Wall-Mounted Gym Ladder

- Steel frame with welded supports for strength and durability
- Powder coated black finish is textured for safety
- Inner braces provide stability for lateral movement
- Ladder is attached with wood stringers (included) and is additionally supported with a heavy-duty chain
- Frame extends 48" from wall
- 18"W x 12'L

3 Year Limited Warranty



WML-100

\$1,905 EA 187 lbs



Vertical Climbing Ladder

- 1 1/8" steel tubing construction
- Powder coated black finish is textured for safety
- Heavy-duty wall mounting plates
- 22"W x 60"L

3 Year Limited Warranty



WVL-7

\$390 EA 33 lbs



Wall Grid Climber

- 1 1/8" steel tubing construction
- Powder coated black finish is textured for safety
- Grid is 4 x 5 rows with 6" pattern
- Heavy-duty wall mounting plates

3 Year Limited Warranty



WGC-20

\$537 EA 72 lbs



Adjustable Wall-Mounted Chinning Bar

- Provides 2' of height adjustment in 6" increments
- All-welded 30" wide steel frame with black powder coat finish

3 Year Limited Warranty

EWM-30

\$200 EA 26 lbs



Jump Rope Rack

- Wall-mounted all steel construction with powder coat finish
- 27" long with (5) 10" long pegs

3 Year Limited Warranty

PE-110

\$51 EA 7 lbs

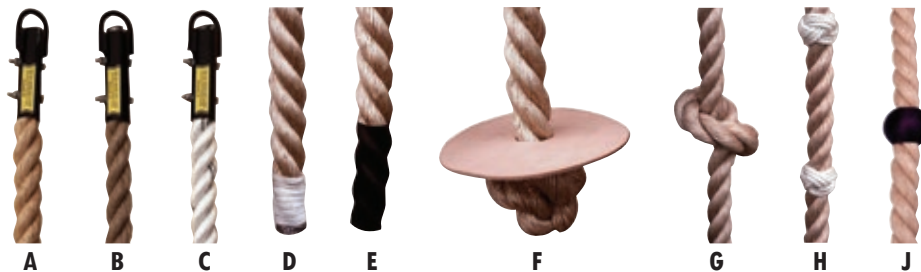

- A. Natural Manila Rope:** Superior quality manila offers the best grip and durability.
- B. Polypro Unmanila Rope:** Same look and feel as manila with added strength and reduced weight.
- C. Polyplus Rope:** Soft, lightweight and has excellent moisture and UV resistant characteristics.
- D. Whipped End:** Standard wrapped end to prevent unraveling.
- E. Polyboot End:** Poly cover permanently attached to the end to prevent unraveling.
- F. Leather Seat on Turk Knot End:** Provides stable starting point for beginner climbers.

1 Year Limited Warranty

STEP 1:

	D	E	F
Select Rope	A CR-1	CR-2	CR-3
Combination	B CRP-1	CRP-2	CRP-3
	C CRD-1	CRD-2	CRD-3

STEP 2: Select Knot Style

- G BK-1** Beginner (large) Knots
- H RGK-1** Rest/Grip Knots
- J RB-1** Rubber Ball

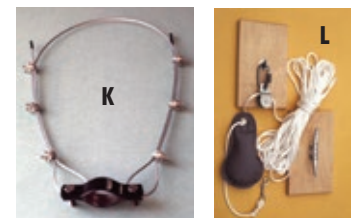

Climbing Rope Accessories

- K SCA-1** Safety Cable Attachment
- L RN-1** Rope Hoist
- M A-3** Adjustable I-Beam Clamp
- N L-1** Quick Link

Call for additional details, pricing and freight quote.



Custom Graphics by Jaypro Sports

Your team logo on post padding, net tapes and more!

IMPORTANT: Prices in chart for graphics only.

1 Year Limited Warranty on Printing/Labels



VOLLEYBALL	Description	Item	Price
Net Tape	Multi-color lettering and graphics	CVNT-1	\$444 EA
Net Side Tapes	Multi-color lettering and graphics	CVNT-2	\$159 PR
Upright Pad	Multi-color lettering and graphics	JSG-VPP	\$222 PER PAD
FOOTBALL	Description	Item	Price
Post Pad	Multi-color lettering and graphics	JSG-FPP	\$222 PER PAD
RUGBY	Description	Item	Price
Post Pad	Multi-color lettering and graphics	JSG-RGP2	CALL FOR PRICING
BASKETBALL	Description	Item	Price
Post Pad	Multi-color lettering and graphics	JSG-BPP2	CALL FOR PRICING
BASEBALL	Description	Item	Price
Cage Skirt Graphics	Multi-color lettering and graphics (5½' maximum width)	SKT-LOGO	\$333 EA

Little Champ™ Backboard Adapters

Convert an existing goal to youth height. Easily installs from floor by one person!

- Safely attaches to any goal and 42" backboard
- Fan-shaped backboard, attachment frame, official size goal, and nylon net included
- Moves backboard 2' closer to free throw line

Limited Warranties: System 3 Year, Net 1 Year



Little Champ™ Easy Adjust Backboard Adapter

- 6½' to 9' height adjustment without disassembly
- Folds down and rolls on wheels for convenient storage
- Arm adapter kit (LC-AKIT) for 48" backboard sold separately

LC-6HP	\$800 EA	49 lbs
LC-6	\$1,488 PR	98 lbs

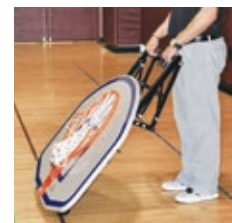
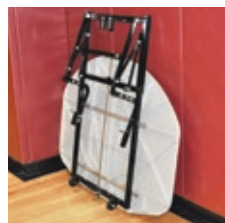

Little Champ™ 8.5 Backboard Adapter

- 8'6" youth regulation height
- Folds down for convenient storage
- Arm adapter kit (LC-AKIT) for 48" backboard sold separately

LC-2HP	\$590 EA	38 lbs
LC-2	\$1,100 PR	76 lbs



For adapting to a 48" high backboard.

Little Champ™ Arm Adapter Kit

LC-AKIT	For 48" Boards	\$159 EA	8 lbs
---------	----------------	----------	-------



Little Champ™ Classic Backboard Adapter

- 8'6" youth regulation height
- Hand knobs secure unit to existing goal

LC-1HP	Each	\$510 EA	46 lbs
LC-1	Pair	\$870 PR	80 lbs
G-35	Goal	\$64 EA	13 lbs

Little Champ™ Replacement Backboard

Goal and net sold separately.



FSGB-1	Backboard	\$245 EA	20 lbs
LC-RIM	Goal	\$142 EA	12 lbs

GymGlide™ Recreational Game Standard

Upright with retractable front swivel wheels for easy mobility. Never tip to move or store!

- 155 lb. cast-iron base
 - Holding capacity equivalent to 220 lb. game standard
 - Adjustable height collars
- Specify base color when ordering.*

3 Year Limited Warranty 

GGG-100RB	Royal Blue	\$598 EA	179 lbs
GGG-100DG	Dark Green	\$598 EA	179 lbs
GGG-100YW	Yellow	\$598 EA	179 lbs
GGG-100RD	Red	\$598 EA	179 lbs
GGG-100W	White	\$598 EA	179 lbs

GymGlide™ base color options:



Safe and easy to move

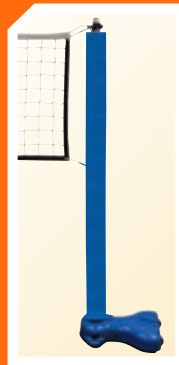

GymGlide™ Package #1

- 2 GymGlide™ Game Standards (GGG-100XX)
 - 2 GymGlide™ Economy Upright Pads (GG-UPAD)
 - 1 Volleyball Net (VBN-32)
- Specify pad & base color when ordering.*

* Limited Warranties 
GGG-100PKG \$1,175 PKG 348 lbs



GymGlide™ Package #2

- 2 GymGlide™ Game Standards (GGG-100XX)
 - 2 GymGlide™ Base Pads (GG-BPAD)
 - 2 Official Standard Pads (PVB60PHP)
 - 1 Volleyball Net (VBN-32)
- Specify base & pad colors when ordering. Custom graphics available on pads at additional cost.*

* Limited Warranties 
GGG-100PKGDX \$2,095 PKG 372 lbs

Standards: 3 Year Limited Warranty, Pads & Net: 1 Year Limited Warranty



P.E. Economy Upright Pad

- 6' tall x 1" thick foam pad with vinyl cover
 - Attaches to upright with hook-and-loop straps
- Specify pad color when ordering.*

1 Year Limited Warranty

GG-UPAD \$65 EA 5 lbs



GymGlide™ Base Pad

- Designed for GymGlide™ game standard base
 - 2" thick foam pad with vinyl cover
- Specify pad color when ordering.*

1 Year Limited Warranty

GG-BPAD \$500 EA 5 lbs

PAD COLORS



Multi-Purpose Game Standards

Versatile game standards with sliding height adjustment collars. Available in three weights (75 lbs., 145 lbs., and 220 lbs.)!

- 10' tall x 2" uprights (two piece)
- 24" dia. steel bases with rubber rims protects floor
- Tip-and-roll transport on non-marking wheels
- Nets sold separately

EXCLUSIVE: Upright hub on base includes tethered safety bolt and two stabilizer jacking screws for an extra margin of safety.

3 Year Limited Warranty



Item #	Size in lbs	Color	Shipping Weight	Price
AS-475R	75	Royal Blue	203 lbs	\$665 PR
AS-475RR	75	Red	203 lbs	\$665 PR
MP-500R	145	Royal Blue	378 lbs	\$865 PR
MP-500RG	145	Green	378 lbs	\$865 PR
MP-500RR	145	Red	378 lbs	\$865 PR
MP-500RW	145	White	378 lbs	\$865 PR
MP-500RY	145	Yellow	378 lbs	\$865 PR
MPC-5145R*	145	Royal Blue	189 lbs	\$500 EA
MP-521R	220	Royal Blue	530 lbs	\$1,075 PR
MP-521RR	220	Red	530 lbs	\$1,075 PR
MPC-5211R*	220	Royal Blue	265 lbs	\$620 EA

* Center pole allows for a two court setup

IMPORTANT SAFETY NOTICE: Game standards are heavy pieces of gymnasium equipment and require proper setup, handling, and maintenance by only trained supervisory personnel.

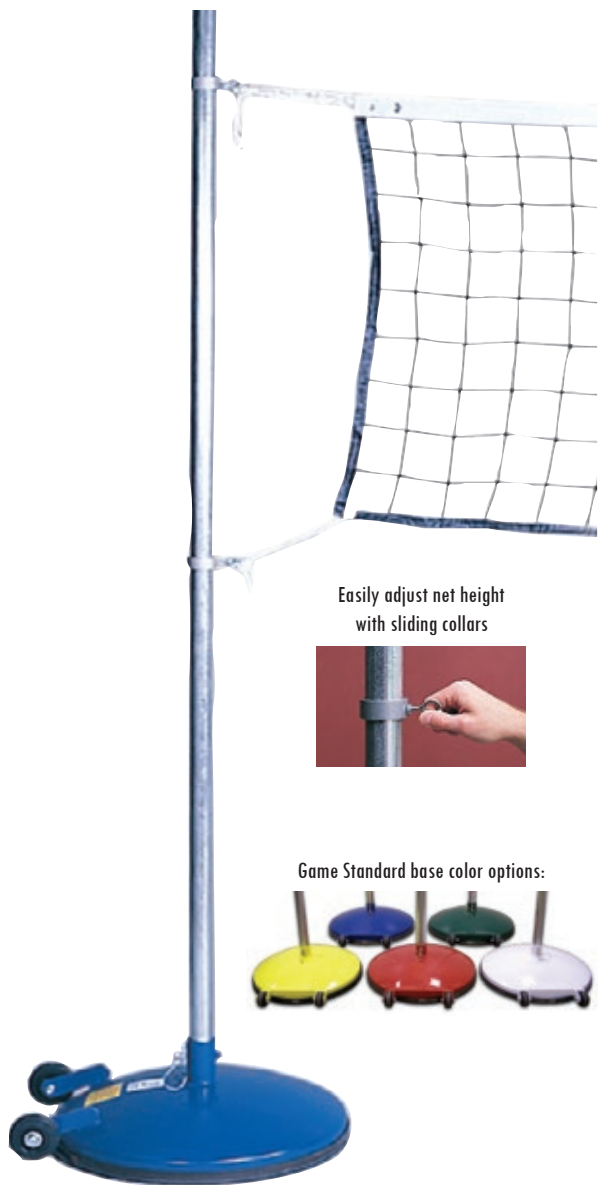

Easily adjust net height with sliding collars



Game Standard base color options:



Base Pad

- Designed for 24" dia. game standard
- 2" thick foam pad with vinyl cover

1 Year Limited Warranty

PBC-24RD	Red	\$150 EA	6 lbs
PBC-24RB	Royal Blue	\$150 EA	6 lbs



Economy Tennis Standards

Indoor/outdoor galvanized steel standards.

- 44" tall x 2" uprights
- 145 lb. rubber trimmed roll-a-way bases
- Net sold separately

3 Year Limited Warranty



JT-175R	\$865 PR	314 lbs
---------	----------	---------

Easy Play Game Standards

Tip-and-roll game standards ideal for a variety of indoor/outdoor sports.

3 Year Limited Warranty



Easy Play Multi-Purpose

Multi-sport standard with sliding height adjustment collars.

- 10' tall x 2" galvanized steel upright (two piece)
- Available as single or pair

EZ-55HP Std. w/ Post \$300 EA 60 lbs

EZ-55 System \$579 PR 158 lbs



- 6 $\frac{3}{8}$ " dia. steel T-bases with non-marking wheels
- Systems (includes 2 bases & posts) or post only models available
- Recreation net options only (VBN-32, BND-1 and TDP-42) sold separately
- Base - 40"W x 32"D

Bases filled with 55 lbs. (minimum) of customer supplied ballast.

Easy Play Game Standards are not designed to achieve competition net tension.

Easy Play Badminton

Easily setup a portable (61"H) badminton court.

- 1 $\frac{7}{8}$ " steel post(s) with white powder coat finish
- Clamcleats® included for securing net cords

EZBSO-3 Std. w/ Post \$611 PR 126 lbs

EZBP Posts Only \$275 PR 12 lbs



Easy Play Pickleball

Easily setup a portable (36"H) pickleball court.

- 2 $\frac{3}{8}$ " steel post(s) with black powder coat finish
- Recommended net (PT-21N) sold separately

EZBPB-4 Std. w/ Post \$611 PR 126 lbs

EZPP Posts Only \$230 PR 12 lbs



Easy Play Tennis

Easily setup a portable (42"H) tennis court.

- 2 $\frac{3}{8}$ " steel post(s) with black powder coat finish
- Recommended net (TDP-42) sold separately

EZTBP-5 Std. w/ Post \$611 PR 135 lbs

EZTP Posts Only \$230 PR 21 lbs

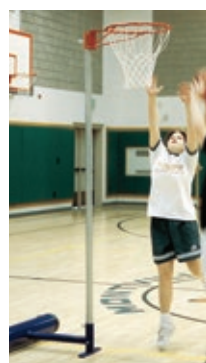

Net Ball Adapter

- Fits any 2" game standard upright
- Goal (G-35), net (JNY-4HP), and mounting hardware included

* Limited Warranties

EZNB-10 \$130 EA 15 lbs



Elementary Basketball Adapter

- 7' max goal height for indoor use only
- Fits any 2" game standard upright
- Goal (G-35), net (JNY-4HP), and mounting hardware included

* Limited Warranties

EZBB-8 \$400 EA 46 lbs

* Adapters: 3 Year Limited Warranty, Net: 1 Year Limited Warranty



Deluxe Game Standards

Deluxe standards with net tensioning ratchet. Tip-and-roll transport on non-marking wheels!

- 8' tall x 2 $\frac{3}{8}$ " galvanized steel uprights
- 24" dia. steel bases with hand knobs and guy wires for anchoring
- 2 floor anchors required per system and sold separately

3 Year Limited Warranty

SS-320R \$900 PR 142 lbs

Deluxe Center Standard

Upright compatible with Deluxe Game Standard (SS-320R) for a two-court set up.

- 2 floor anchors required per center standard and sold separately

3 Year Limited Warranty

SSC-321R \$585 EA 75 lbs



Volleyball Net

- Rope Cable - 32'L x 36"H

1 Year Limited Warranty

VBN-32 \$102 EA 4 lbs



Badminton Net

- Rope Cable - 21'L x 30"H

1 Year Limited Warranty

BND-1 \$62 EA 7 lbs



Tennis Net

- Rope Cable - 42'L x 42"H

1 Year Limited Warranty

TDP-42 \$155 EA 10 lbs

Semi-Permanent Outdoor Tetherball Pole

- 2" galvanized steel upright is 8 $\frac{1}{2}$ ' tall (installed)
- 18" ground sleeves with top cap included
- Tetherball (TBP-BALL) sold separately

3 Year Limited Warranty



TBP-200 \$190 EA 18 lbs

Portable Tetherball Pole

Indoor/outdoor unit with pre-assembled leader chain. Tip-and-roll transport on non-marking wheels!

- 10' tall x 2" galvanized steel upright
- 24" dia. steel base with protective rubber trim
- Tetherball (TBP-BALL) sold separately

3 Year Limited Warranty



TBP-275R \$440 EA 99 lbs

Heavy-Duty Permanent Tetherball Pole

- 2 $\frac{3}{8}$ " galvanized steel pole with cap and leader chain
- Tetherball (TBP-BALL) sold separately

3 Year Limited Warranty



TBP-250 \$222 EA 38 lbs

Tetherball

- Ultra-cushioned, sponge rubber construction
- Recessed rope holder and nylon rope included

3 Year Limited Warranty

TBP-BALL \$24 EA 3 lbs



Portable



Deluxe Floor Hockey Goals

Lightweight goals with rubber feet protect gymnasium floors.

- 1 5/16" galvanized steel frames with cast aluminum corner fittings
- Polyethylene nets with colored sleeves (1 red and 1 blue) included
- Replacement nets (FHN-36) available
- Dimensions: 6'W x 4'H x 20"D

* Limited Warranties

FHGN-33	Goal	\$799 PR	78 lbs
FHN-36	Replacement Nets	\$150 PR	9 lbs

* Goal: 3 Year Limited Warranty, Net: 1 Year Limited Warranty



Folding Multi-Purpose Goals

Durable goals for quick indoor/outdoor games.

- 1 5/16" steel frames fold and roll for convenient storage
- Knotless nets with colored sleeves (1 red and 1 blue) included
- Dimensions: 6'W x 4'H

* Limited Warranties

FHG-46PR	Goals	\$455 PR	39 lbs
FHG-46N	Red Net	\$98 EA	5 lbs
STG-46N	Blue Net	\$98 EA	4 lbs

* Goal: 3 Year Limited Warranty, Net: 1 Year Limited Warranty



Archery Target Stand

Adjustable target stand for 24" to 48" targets.

- Target not included

3 Year Limited Warranty

PE-120	\$90 EA	14 lbs
---------------	---------	--------



Archery Target Tripod

Adjustable target tripod for 24" to 48" targets. Collapses for compact storage!

- Target not included

3 Year Limited Warranty

PE-121	\$65 EA	8 lbs
---------------	---------	-------



Torso Flexibility Box

- Accurate measurement in inches/centimeters
- Steel design with footrest plate
- 20"L x 12"W x 12"H

3 Year Limited Warranty

PE-FLBXX	\$115 EA	13 lbs
-----------------	----------	--------



Throw Down Bases

- 3 bases, home plate, and pitching rubber

3 Year Limited Warranty

BB-50	\$19 SET	8 lbs
--------------	----------	-------



Jump Rope Rack

- 27" wall-mounted storage rack
- (5) 10" long pegs for storage

3 Year Limited Warranty

PE-110	\$51 EA	7 lbs
---------------	---------	-------



Item #	Capacity	Size	Weight	Price
OBR-16	16	102"L x 30"W x 30"H	67 lbs	\$787 EA
OBR-10	10	67"L x 30"W x 30"H	60 lbs	\$670 EA
OBR-8	8	55"L x 30"W x 30"H	49 lbs	\$616 EA
OBR-6	6	47"L x 30"W x 30"H	56 lbs	\$547 EA

Portable Bicycle Rack

Durable all-welded rack for bicycles and mopeds. Available in 4 sizes!
 • Galvanized steel frame with gray powder coat finish
Call for freight quote.

3 Year Limited Warranty

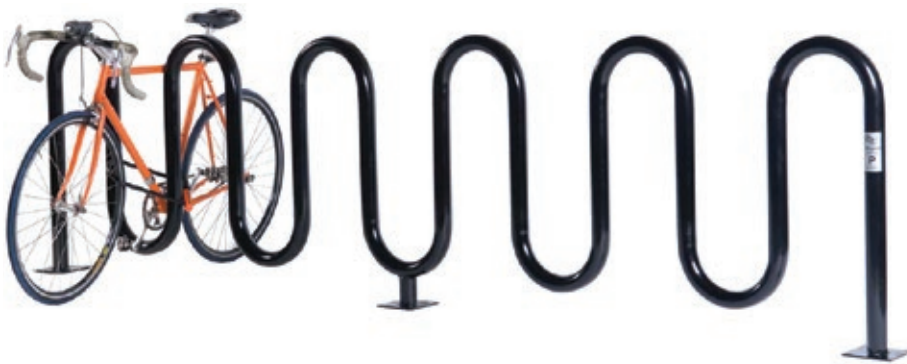

Colors: Black, Red, Orange, Yellow, Blue, Light Green, Dark Green, Brown, Light Grey, and Dark Grey.

Wave Bicycle Rack

- 1.66" dia. tubing with contemporary design
 - 36" tall x 12" spacing between waves
 - In-ground or surface mount installation
- Specify rack color when ordering. Call for freight quote.*

	Capacity	Length	Weight	Galvanized	Price	Powder Coat	Price
Below Grade Mount	7	64"	80 lbs	HDWBR-7	\$685 EA	HDWBR-7PC	\$670 EA
	9	87"	120 lbs	HDWBR-9	\$930 EA	HDWBR-9PC	\$920 EA
Surface Mount	7	64"	80 lbs	HDWBR-7SM	\$659 EA	HDWBR-7SMPC	\$659 EA
	9	87"	120 lbs	HDWBR-9SM	\$891 EA	HDWBR-9SMPC	\$891 EA

1 Year Limited Warranty



Single Sided Bike Racks

Single sided grid racks are a great option for short term bike storage and easily accommodates smaller bikes in school settings.

- Easy to move for maintenance
 - Free standing for flexibility in space required
 - Dimensions: 62" x 26" x 31" (5 Bike)
 - Dimensions: 111" x 26" x 31" (9 Bike)
- Call for freight quote.*

Item #	Capacity	Weight	Price
SSBR5	5	41 lbs	\$299 EA
SSBR9	9	69 lbs	\$385 EA

1 Year Limited Warranty





best seller

The Original ToteMaster[™]

Indoor/outdoor all-purpose carrier. No tools required for assembly.

- Holds 20-25 balls
- Lockable hinged top (lock not included)
- 36" L x 24" W x 36" H

3 Year Limited Warranty

TE-2	Royal Blue	\$212 EA	44 lbs
TE-2BK	Black	\$212 EA	44 lbs

Replacement Caster and Insert Kit

- 4 non-marking 3" swivel casters and inserts
Specify push-in or screw-in model needed when ordering.



3 Year Limited Warranty

TE-2HK		\$42 KIT	4 lbs
---------------	--	----------	-------



Mini ToteMaster[™]

Indoor/outdoor all-purpose carrier. No tools required for assembly.

- Holds 10-12 balls
- Lockable hinged top (lock not included)
- 21" L x 21" W x 30" H

3 Year Limited Warranty

TE-30		\$200 EA	24 lbs
--------------	--	----------	--------



ToteMaster[™] Plus

All-purpose carrier with large storage capacity.

- Holds 30-35 balls
- Divider included to separate equipment
- Lockable hinged dual tops (lock not included)
- 60" L x 24" W x 36" H

3 Year Limited Warranty

TE-60		\$350 EA	63 lbs
--------------	--	----------	--------

best seller



ToteMaster™ All-Terrain

Durable indoor/outdoor all-purpose carrier.

- 12" all-terrain wheels on rear
- Lockable hinged top (lock not included)
- 36" L x 24" W x 36" H

3 Year Limited Warranty

AT-5 \$300 EA 50 lbs



ToteMaster™ Field

Durable indoor/outdoor all-purpose carrier.

- 20" all-terrain wheels on rear
- Lockable hinged top (lock not included)
- 51" L x 25" W x 48" H

3 Year Limited Warranty

AT-10 \$395 EA 62 lbs



ToteMaster™ Open Top

All-purpose carrier with open top storage baskets.

- Rotating hangers included for jump rope and hoop storage
- Optional side shelf (TE-PESHELF) sold separately
- 48" L x 26" W x 54" H

3 Year Limited Warranty

TE-PE01 \$260 EA 46 lbs



ToteMaster™ Deluxe Open Top

All-purpose carrier with open top storage baskets, rotating hangers, and side shelf.

- All-terrain wheels on rear
- Additional side shelves (TE-PESHELF) sold separately
- 48" L x 26" W x 54" H

3 Year Limited Warranty

TE-PE02 \$320 EA 56 lbs

Atlas Series™ Ball Carts & Lockers

Heavy-duty ball carts and lockers that survive the test of time. Strong enough to store medicine balls!

- 1" thick-walled steel frames with royal blue powder coat finish
- Non-marking swivel casters (Ball Locker & Hamper (BBABL-2) has all-terrain wheels on rear)
- Ball lockers include lockable hinged top (lock not included)

3 Year Limited Warranty



Atlas Series™ Ball Locker

- Holds 25+ balls
- 47"L x 24"W x 37"H

BBABL-1

\$360 EA 55 lbs



Atlas Series™ Ball Locker & Hamper

- Holds 25+ balls
- Mesh hamper liner included for towels/uniforms storage
- 45"L x 24"W x 35"H

BBABL-2

\$380 EA 80 lbs



Atlas Series™ Ball Cart

- Holds 15 balls
- 51½"L x 18"W x 36"H

BBABC-1

\$250 EA 31 lbs



Atlas Series™ Double Ball Cart

- Holds 30 balls
- 51½"L x 24"W x 36"H

BBABC-2

\$340 EA 52 lbs



StackMaster™ Wall Racks

Heavy-duty steel ball racks permanently mount to gymnasium wall.

- Lockable top/bottom bars (lock not included)
- Mounting hardware not included
- Single Wall Rack - 15"W x 66"H x 12"D
- Double Wall Rack - 37"W x 66"H x 12"D

3 Year Limited Warranty

PE-140	Single	\$115 EA	18 lbs
PE-240	Double	\$200 EA	49 lbs



Deluxe Training Ball Rack

Durable steel rack for shooting competitions and free throw practice.

- Holds 19 regulation basketballs (top 7 feed to shooter)
- Non-marking swivel wheels (front 2 lockable)
- 61"L x 18"W x 44"H

3 Year Limited Warranty

DTBR-19	\$225 EA	40 lbs
----------------	----------	--------

Premium Ball Carrier

Durable steel frame carrier with side panels for custom graphics on both ends.

- Non-marking swivel wheels
 - 39"L x 22"W x 36"H
- Specify graphics when ordering.*

3 Year Limited Warranty

DTBR-12	\$199 EA	30 lbs
----------------	----------	--------



Deluxe Ball Carriers

Durable steel frame carriers hold basketballs, volleyballs, and medicine balls.

- Non-marking swivel wheels
- 12 Ball Carrier - 39"L x 22"W x 36"H
- 18 Ball Carrier - 60"L x 22"W x 36"H

3 Year Limited Warranty

BBC-12RB	12 Ball - Royal Blue	\$134 EA	26 lbs
BBC-12BK	12 Ball - Black	\$134 EA	26 lbs
BBC-12RD	18 Ball - Red	\$134 EA	26 lbs
BBC-18RB	18 Ball - Royal Blue	\$150 EA	41 lbs
BBC-18BK	18 Ball - Black	\$150 EA	41 lbs
BBC-18RD	18 Ball - Red	\$150 EA	41 lbs



Holds
Basketballs
Medicine Balls
Volleyballs



BBC-12RD



BBC-18RB



Portable FieldPro™ Net System Package

Keep balls on the field and ensure the safety of spectators.

- 4 poles with black powder coat finish
- 4 bases with (16) 5 gallon jugs
- 1¾" knotted nylon net
- Red vinyl base covers included
- 60'L x 12'H

* Limited Warranties



PFN-1260PKG

\$3,480 EA 510 lbs

* System: 3 Year Limited Warranty, Net & Covers: 1 Year Limited Warranty

FIELDPRO™ NET SYSTEM



Portable FieldPro™ Net System

Lightweight indoor/outdoor portable net system for fields and courts where in-ground sleeve systems are not an option. Can also be used as a multi-field/court space divider!

- Easy net assembly with cable clamps and sliding rings
- 12' tall x 2¾" dia. aluminum poles on tip-and-roll bases with no-flat tires
- Counterweight containers and corrosion-resistant hardware included
- Optional vinyl base covers (PFN-BCVR) sold separately

Poles can be powder coated black (specify when ordering). Typical pole spacing is 18' apart and should not exceed 20'. Sold per base dependent on overall length needs (specify when ordering). Call for quote.

NOTE: It is the customer's responsibility to fill counterweight containers.

FieldPro™ Net System Base Cover

Vinyl base cover slides over counterweight containers. Standard color is red.

1 Year Limited Warranty



PFN-BCVR

Red

\$60 EA

1 lb





FieldPro™ Multi-Sport Net System

Ball stop net system for lacrosse, field hockey, and other field sports. Ensure the safety of athletes, coaches, and spectators!

- (4) 4" heavy-walled aluminum uprights, ground sleeves, and covers
 - #36 knotted black nylon net with 1¾" sq. mesh
 - Pulley system and corrosion-resistant hardware included
- Standard upright color is black. Specify preferred pole color when ordering. Call for freight quote.*

* Limited Warranties



FNMB-65 65'W x 15'H \$2,610 EA 225 lbs

* System: 3 Year Limited Warranty, Net: 1 Year Limited Warranty



FieldPro™ Football Net System

Keep field goals and extra point kicks away from spectators and inside the field.

- (2) 6⅝" heavy-walled aluminum uprights, ground sleeves, and covers
- #36 knotted black nylon net with 3½" sq. mesh
- Pulley system and corrosion-resistant hardware included
- 30' and 40' models

Standard upright color is natural finish. Specify preferred pole color when ordering. Call for freight quote.

* Limited Warranties



FNFB-30 40'W x 30'H \$4,770 EA 530 lbs
FNFB-40 40'W x 40'H \$7,434 EA 762 lbs

* System: 3 Year Limited Warranty, Net: 1 Year Limited Warranty



FieldPro™ Soccer Net System

Ensure the safety of athletes, coaches, and spectators.

- (4) 4" heavy-walled aluminum uprights, ground sleeves, and covers
- #36 knotted black nylon net with 3½" sq. mesh
- Pulley system and corrosion-resistant hardware included

Standard upright color is black. Specify preferred pole color when ordering. Call for freight quote.

* Limited Warranties



FNSB-65 65'W x 20'H \$2,390 EA 250 lbs

* System: 3 Year Limited Warranty, Net: 1 Year Limited Warranty

Custom **FIELDPRO**TM NET SYSTEM



Seven Different Heights and Pole Styles

10' Straight Pole with multi-sport net is ideal for use as a Lacrosse and Field Hockey backstop net. The net is clipped at the top and bottom of each pole.

15', 20', 25', 30', and 40' Straight Pole comes with a hoist system allowing quick and easy lowering/removal of the net after the game, season, or before a big storm. Reinstalling the net is a snap - all from ground level with no need for a ladder.

20' Offset Pole provides 3' of offset which is ideal for use around the perimeter of soccer and baseball/softball fields. It's also an added measure of safety from ricocheting balls.

Basic Features

- Pulley system to raise/lower net (excludes 10' poles)
- Ground sleeves facilitate installation and allow for system removal as needed
- Covers for ground sleeves are sold separately

* Limited Warranties



Visit JayproSpecs.com to access detailed specification sheets for FieldProTM Net Systems.

Call for freight quote and pricing.

System: 3 Year Limited Warranty, Net: 1 Year Limited Warranty

Pole	Pole Description	Net	Net Description
FN-10	10' tall straight 2 $\frac{3}{8}$ " OD heavy-walled aluminum pole	FN-A	#36 knotted multi-sport UV treated nylon net with 1 $\frac{3}{4}$ " sq. mesh and $\frac{1}{4}$ " rope border
FN-15	15' tall straight 4" OD heavy-walled aluminum pole	FN-B	#36 knotted soccer/football UV treated nylon net with 3 $\frac{1}{2}$ " sq. mesh and $\frac{1}{4}$ " rope border
FNS-20	20' tall straight 4" OD heavy-walled aluminum pole	FN-C	HTPP knotless UV treated net with 1 $\frac{3}{4}$ " sq. mesh and $\frac{1}{4}$ " rope border
FNS-25	25' tall straight 6 $\frac{5}{8}$ " OD heavy-walled aluminum pole	FN-D	HTPP knotless UV treated net with 4" sq. mesh and $\frac{1}{4}$ " rope border
FNS-30	30' tall straight 6 $\frac{5}{8}$ " OD heavy-walled aluminum pole		
FNS-40	40' tall straight 6 $\frac{5}{8}$ " OD heavy-walled aluminum pole		
FNO-20	20' tall offset 4" OD heavy-walled aluminum pole		
FN-SPECIAL	Custom for your facility		



6 Pole Layout

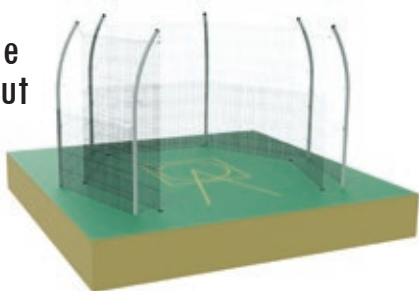

NFHS COMPLIANT

Discus Cage

Durable semi-permanent discus cage with pulley system to setup/remove net. Ideal for high schools.

- (6) 4" heavy-walled aluminum poles (14'6" tall with 24" offset)
- Individual swivel pulley hoist system per pole
- Black powder coat or mill finish
- Heavy-duty weather treated 1 7/8" #42 nylon mesh black net
- Ground sleeves (DCHS-6S) and barrier net (DCHS-BN) sold separately

Call for freight quote.

* Limited Warranties



DCHS-35	Discus Cage w/Net - No Sleeves	\$3,028 EA	500 lbs
DCHS-35NET	Replacement Cage Net - 55'L x 14'H	\$533 EA	19 lbs
DCHS-6S	Replacement Ground Sleeves - Set of 6	\$885 SET	42 lbs
DCHS-35BN	(DCHS-35) + Barrier Net - No Sleeves	\$3,439 EA	575 lbs
DCHS-BN	Replacement Barrier Net - 63'L x 7'H	\$485 EA	15 lbs

* Cage & Sleeves: 3 Year Limited Warranty, Net: 1 Year Limited Warranty

4 Pole Layout

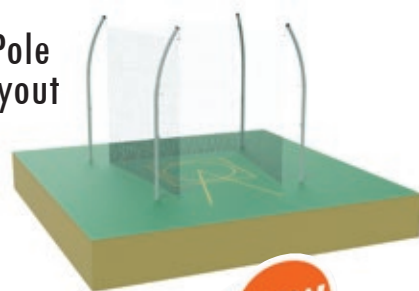

Shot Cage

- Accommodates throwing sector at 34.92 degrees
 - (4) 4" O.D. curved aluminum poles with 2' offset
 - Individual swivel pulley hoist system per pole
 - Black powder coat or mill finish
 - Heavy-duty weather treated 1 7/8" #42 nylon mesh black net
 - Ground sleeves (SC-25S) sold separately
- Call for freight quote.

* Limited Warranties



SC-25	Cage	\$2,899 EA	500 lbs
SC-25S	Ground Sleeves (Set of 4)	\$199 SET	18 lbs

* Cage & Sleeves: 3 Year Limited Warranty, Net: 1 Year Limited Warranty



Ceiling Suspended Retractable Throwing Cage

Nets can be mounted to a retractable frame or extend the full ceiling height. Net configuration may be straight or U-shaped to meet USTF, NCAA, and NFHS requirements.

Cage easily raises and lowers from ceiling via electric winch(s).

Call for details, pricing and freight quote.



Webbed Circles / Rings

Discus and shot/hammer rings with welded cross braces for added rigidity. Bolted together before installation to ensure circle stays round. *Call for freight quote.*

TFTC-SHC	Shot/Hammer	\$771 EA	67 lbs
TFTC-DC	Discus	\$793 EA	85 lbs



Official Circles

Shot and discus circles made of 1" x 3/4" x 1/4" aluminum. Four sections with anchoring holes. *Call for freight quote.*

TFSR	Shot	\$243 EA	10 lbs
TFDR	Discus	\$243 EA	10 lbs



Cast Aluminum Toeboard Pads

Depressed pads and level pads are cast aluminum construction and meet all rule specifications. *Call for freight quote.*

TFTB-ADP	Depressed Pad	\$555 EA	28 lbs
TFTB-ALP	Level Pad	\$555 EA	28 lbs



Poly Toeboard Depressed Pad

Designed with Linear Low-Density Polyethylene (LLDPE) and UV stabilizer for maximum durability. *Call for freight quote.*

TFTB-PLY		\$369 EA	13 lbs
-----------------	--	----------	--------



TFH-HS



TFH-C



High School Hurdle

Stackable, aluminum design with spring loaded buttons for easy height adjustment of 30", 33", 36", 39" & 42". Welded base construction for superior strength. Meets all NFHS pullover weights. *Call for freight quote.*

Collegiate Hurdle

Extruded aluminum base with beveled edges make for a sleek and stable easy stack design. Spring-loaded riser adjusts from 30", 33" 36", 39" & 42" and spring-loaded weights easily adjust to correct pullover weight for all heights. *Call for freight quote.*



Hurdle Cart



Heavy-duty 6-wheel steel cart carries 8-14 hurdles. Unique design helps transport hurdles over curbs and through rough grass or loose gravel. Cart accommodates both high school and collegiate hurdles. *Call for freight quote.*

3 Year Limited Warranty



TFH-HS	High School Hurdle	\$200 EA	25 lbs
TFRH-HS	High School Rocker Hurdle	\$162 EA	21 lbs
TFH-C	Collegiate Hurdle	\$255 EA	29 lbs
TFH-CART	Hurdle Cart	\$679 EA	115 lbs



TFSB-HS

TFSB-C

High School Starting Block

Lightweight aluminum construction starting system has 5" wide 4 position adjustable pedals and a 3" center rail. All-weather spikes included. *Call for freight quote.*

Collegiate Starting Block

Highest quality lightweight all aluminum casting starting system with 5 pedal angle adjustments. Pedals will not come off rail during transport. Includes a center rail for carrying, threaded spikes for synthetic surface and threaded spike inserts. *Call for freight quote.*

3 Year Limited Warranty

TFSB-HS	High School	\$133 EA	11 lbs
TFSB-C	Collegiate	\$404 EA	14 lbs

3 Year Limited Warranty on all items on pages 136-137

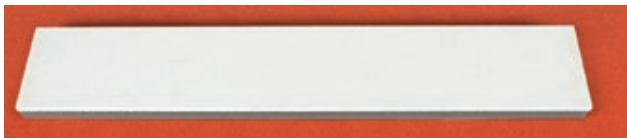

8" Long Jump Take-Off Board

Official 48" x 8" take-off board. 3/4" polyurethane top surface on 1 1/2" x 8" plastic under board. *Call for freight quote.*

TFLJ-B \$245 EA 26 lbs



8" Long/Triple Jump Take-Off Board Tray

8" zinc plated steel tray system. Board mounted to steel framework with 6 adjusting bolts. *Call for freight quote.*

TFLJ-P8 \$661 SYS 42 lbs

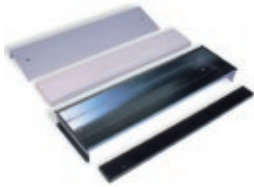

12" Long/Triple Jump Take-Off Board System

12" tray system with take-off board, 1/2" plywood foul board, and heavy-duty steel lid. Foul board can be replaced with plasticine for meets. *Call for freight quote.*

TFLJ-W12L \$1,350 EA 110 lbs



20" Long/Triple Jump Take-Off Board

Two part poly board with soft texture 3/4" top board attached to a high density 3/4" poly under board. *Call for freight quote.*

TFLJ-P20 \$334 EA 42 lbs



20" Long/Triple Jump Take-Off Board Tray

20" stainless steel tray system with drain holes for permanent installation in synthetic runways. *Call for freight quote.*

TFLJ-TR \$464 EA 36 lbs

3 Year Limited Warranty on all items on pages 136-137

Sand Pit Forms



Structure is made of specially folded 1/8" aluminum with built in ledge to receive sand pit cover. The sand catcher system with included covers, allows sand to be conveniently stored when the pit is covered. Minimum distance from takeoff board to back of pit is 10 meters. Available in 3 sizes. *Call for freight quote.*



3 Year Limited Warranty



TFSP-23	23'	\$12,000 EA	2,500 lbs
TFSP-26	26'	\$13,300 EA	2,700 lbs
TFSP-29	29'	\$14,000 EA	2,900 lbs



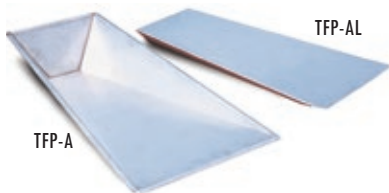

Aluminum Pole Vault Box

1/8" thick walled vault box with 1/4" bottom/backstop and welded construction. Optional aluminum lid with middle supports sits flush with top of vault box. May be covered with all-weather track material. *Call for freight quote.*



3 Year Limited Warranty

TFP-A	Box	\$507 EA	38 lbs
TFP-AL	Lid	\$479 EA	35 lbs

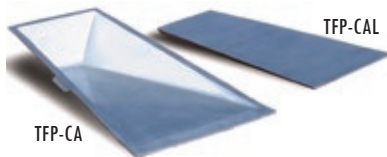

Cast Aluminum Pole Vault Box

Thick walled aluminum casting with rounded inside corners for easy rotation of pole in box. Optional lid has textured surface to match runway. *Call for freight quote.*



3 Year Limited Warranty

TFP-CA	Box	\$815 EA	38 lbs
TFP-CAL	Lid	\$404 EA	35 lbs



Steel Pole Vault Boxes

Pole vault boxes available in heavy gauge steel with white paint finish or smooth finished 12 gauge stainless steel. Optional steel lid available. *Call for freight quote.*

3 Year Limited Warranty

TFP-S	Steel Box	\$378 EA	40 lbs
TFP-SS	Stainless Steel Box	\$780 EA	65 lbs
TFP-SL	Steel Lid	\$327 EA	35 lbs



Pole Vault Landing Systems

Uniquely fabricated landing systems with varying densities. Reinforced vinyl coating (22 oz. for high school and 18 oz. for collegiate styles) with spike resistant top pad. Vinyl Colors: Black, Gray, White, Yellow, Orange, Red, Maroon, Purple, Kelly Green, Light Blue, Royal Blue and Navy. *Specify vinyl color when ordering. Call for freight quote.*

13 Year Limited Warranty

TFP-LSHS	High School	20' x 21' x 26"	\$14,430 SYS	875 lbs
TFP-LSC	Collegiate	22' x 24' x 28"	\$20,370 SYS	1,230 lbs

Pole Vault All Weather Covers

Cover Mesh Colors: Black, Gray, White, Red, Royal, Kelly Green, Orange, Gold and Purple. *Specify cover mesh color when ordering. Call for freight quote.*

1 Year Limited Warranty

TFP-LSCHS	High School	\$775 EA	85 lbs
TFP-LSCC	Collegiate	\$1,950 EA	105 lbs



High School Pole Vault Standard

Pole standard adjusts from 6' to 18'. Durable rust-resistant steel risers have easy grip handles for height adjustment and "spin t-handles" to lock riser in place. Base with 32" adjustability. *Call for freight quote.*

Collegiate Pole Vault Standard

Aluminum uprights with telescoping riser adjusts from 9' to 21'. Uprights are mounted on offset steel carriage that rides on pulley wheels (adjusts from 0-32"). Meets IAAF, NCAA and NFHS rules. *Call for freight quote.*

1 Year Limited Warranty

TFP-STHS	High School Pole Vault Standard	\$1,644 PR	232 lbs
TFP-STC	Collegiate Pole Vault Standard	\$2,633 PR	427 lbs
TFP-XB	14' 10" Crossbar	\$116 EA	8 lbs

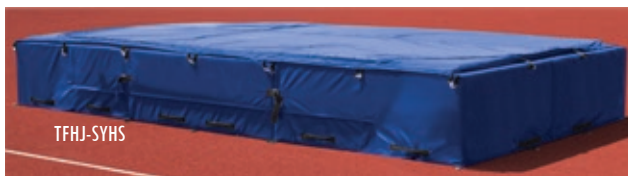

TFHJ-SYHS

NFHS
COMPLIANT



TFHJ-SYCHS



TFHJ-SYC

NCAA
COMPLIANT

NFHS
COMPLIANT

IAAF
COMPLIANT



TFHJ-SYCC

High Jump Landing Systems



Three base sections buckle at ends with seams covered by 3" hook-and-loop strips. 2" top pads cover sections. Vinyl Colors: Black, Gray, White, Yellow, Orange, Red, Maroon, Purple, Kelly Green, Light Blue, Royal Blue and Navy.

Specify vinyl color when ordering. Specify design for collegiate model when ordering. Call for freight quote.

13 Year Limited Warranty



High School Straight Front Design

TFHJ-SYHS 18'W x 10'D x 28"H \$5,685 SYS 220 lbs

Collegiate Straight Front or Front Cut-Out Design

TFHJ-SYC 16'6"W x 8'D x 26"H \$8,040 SYS 315 lbs

High Jump All Weather Covers

Cover Mesh Colors: Black, Gray, White, Red, Royal, Kelly Green, Orange, Gold and Purple.

Specify cover mesh color when ordering. Specify design for collegiate model when ordering. Call for freight quote.

1 Year Limited Warranty



High School Straight Front Design

TFHJ-SYCHS \$775 EA 38 lbs

Collegiate Straight Front or Front Cut-Out Design

TFHJ-SYCC \$1,150 EA 53 lbs

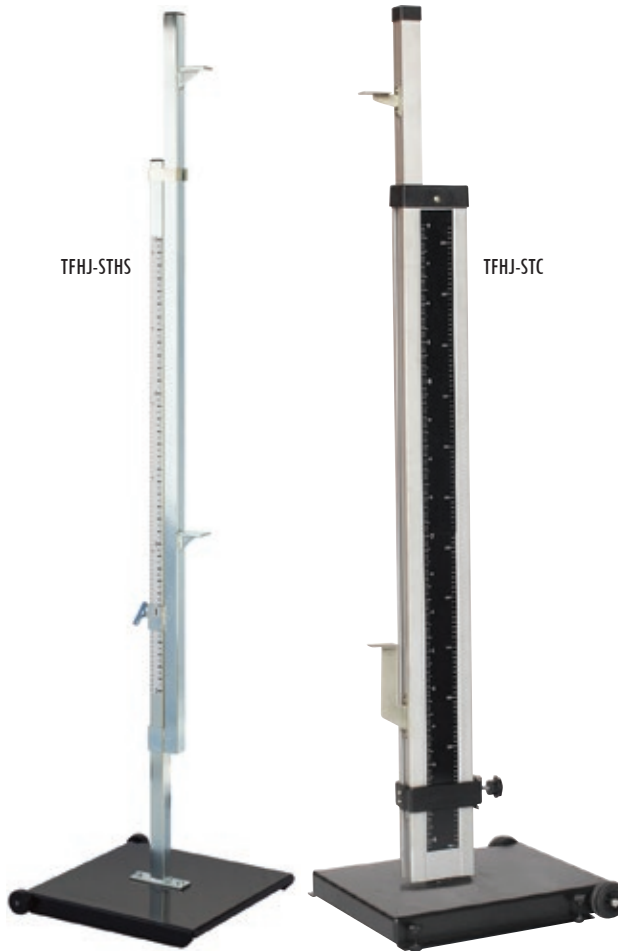

TFHJ-STHS

TFHJ-STC



TFHJ-XB



High School High Jump Standard

Zinc plated water-resistant standards adjust from 2' to 8' in ¼" intervals. 16" base with roll away feature. Metric scale in cm. 62 to 244. Call for freight quote.

Collegiate High Jump Standard

Aluminum uprights with telescoping riser adjusts from 1½' to 9'. Steel roll away base with adjusting leveling screws. Measurements in standard and metric. Call for freight quote.

NCAA
COMPLIANT

NFHS
COMPLIANT

IAAF
COMPLIANT

1 Year Limited Warranty



High School High Jump Standard

TFHJ-STHS \$695 PR 61 lbs

Collegiate High Jump Standard

TFHJ-STC \$1,014 PR 105 lbs

13' 1½" Crossbar

TFHJ-XB \$116 EA 8 lbs



RTP-300 RTP-300BK STP-200 STP-200BK

3" Club Tennis Posts

- Available in 3" round or square posts
- 11 gauge steel construction
- Solid stainless steel internal worm gear winch with self-locking mechanism to prevent recoiling during winding
- Welded lacing rods for net attachment included
- Removable winch handle
- Nets (TTN-3, TPL-5, CCPTN42) sold separately
- Ground sleeves (RTPGS-3, STPGS-2) for semi-permanent installation sold separately

3 Year Limited Warranty

RTP-300	Round - Green	\$316 PR	47 lbs
RTP-300BK	Round - Black	\$316 PR	47 lbs
STP-200	Square - Green	\$316 PR	58 lbs
STP-200BK	Square - Black	\$316 PR	58 lbs

Replacement Winch

Round Winch and Handle		
RTP-300WH	\$99 EA	4 lbs
Square Winch and Handle		
STP-200WH	\$99 EA	4 lbs

3" Ground Sleeves

Ground Sleeves (RTP-300) - 24"L		
RTPGS-3	\$119 PR	12 lbs
Ground Sleeves (STP-200) - 24"L		
STPGS-2	\$130 PR	12 lbs



2 7/8" Tennis Posts

- 2 7/8" heavy-walled steel pipe
- Heavy-duty self-locking winch with removable handle
- Low profile die cast top cap
- Adjustable height stop
- Semi-permanent installation capable
- 2 powder coat colors with zinc undercoat available
- Ground sleeves with caps and net sold separately

3 Year Limited Warranty

RTP-278BK	Black Post	\$362 PR	45 lbs
RTP-278	Green Post	\$362 PR	45 lbs
TP-278G	Ground Sleeves & Covers	\$155 PR	12 lbs
RT-10GR	Repl. Green Ratchet Reel	\$80 EA	3 lbs
RT-10BLK	Repl. Black Ratchet Reel	\$80 EA	3 lbs
CAP-10GR	Repl. Green Top Cap	\$31 EA	3 lbs
CAP-10BLK	Repl. Black Top Cap	\$31 EA	3 lbs



3 1/2" Heavy-Duty Tennis Posts

- 3 1/2" heavy-walled round steel green posts
- Steel top pulley caps with 1 3/4" dia. aluminum pulley
- Tensioning ratchet with spring-loaded safety latch
- Removable handle
- Assembly hardware included
- Nets (TTN-3, TPL-5, CCPTN42) sold separately
- Ground sleeves (TP-150G) for semi-permanent installation sold separately

3 Year Limited Warranty

TP-125	Green	\$389 PR	90 lbs
TPGS-35	Galvanized	\$405 PR	68 lbs
TP-150G	3 1/2" Sleeves	\$180 PR	12 lbs

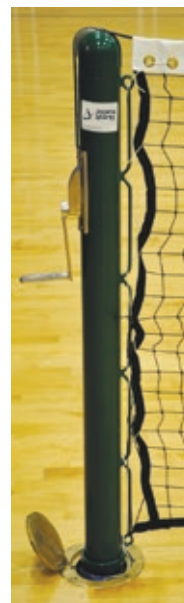

3" Deluxe Indoor Tennis Posts

- 3" round posts
- Designed for use with standard 3" x 10" indoor floor sleeves and cover (see page 14).
- Solid stainless steel internal worm gear winch with self-locking mechanism to prevent recoiling during winding
- Removable winch handle
- Net sold separately

3 Year Limited Warranty

ITS-300	\$544 PR	46 lbs
----------------	----------	--------



Deluxe Pickleball Posts

- Official 36" height
- 2 7/8" heavy-walled steel pipe
- Heavy-duty self-locking winch with removable handle
- Low profile die cast top cap
- Adjustable height stop
- Semi-permanent installation capable
- 2 powder coat colors with zinc undercoat available
- Ground sleeves with caps and net sold separately

3 Year Limited Warranty

PPR10BK	Black Post	\$365 PR	46 lbs
PPR10GR	Green Post	\$365 PR	46 lbs
TP-278G	Ground Sleeves & Covers	\$155 PR	12 lbs
RT-10GR	Replacement Green Ratchet Reel	\$80 EA	3 lbs
RT-10BLK	Replacement Black Ratchet Reel	\$80 EA	3 lbs
CAP-10GR	Replacement Green Top Cap	\$31 EA	3 lbs
CAP-10BLK	Replacement Black Top Cap	\$31 EA	3 lbs



Indoor Pickleball Posts



- Official 36" height
- 10" in-ground depth
- 2 7/8" heavy-walled steel pipe
- Heavy-duty self-locking winch with removable handle
- Low profile die cast top cap
- 2 powder coat colors with zinc undercoat available
- Floor sleeves with covers (PPR-15G) and net (PT-21N) sold separately

3 Year Limited Warranty

PPR15BK	Black Post	\$399 PR	40 lbs
PPR15GR	Green Post	\$399 PR	40 lbs
PPR-15G	Floor sleeves & covers	\$265 PR	24 lbs



Portable Pickleball Net Set



Game quicker and easier on nearly any surface with this set. Meets USAPA requirements!

- Powder coated frame
- Adjustable straps for net tension
- Carry bag with wheels and net included
- 22'L x 34"H

1 Year Limited Warranty

PKBL10	System	\$133 EA	23 lbs
---------------	--------	----------	--------



Ratchet Reel (for TP-125)

- Heavy-duty ratchet reel fits existing posts
- Removable handle
- Safety latch to prevent fly-away

3 Year Limited Warranty

RT-5GR	Green	\$107 EA	5 lbs
RT-5BK	Black	\$107 EA	5 lbs

Top Cap (for TP-125)



- Fits 3½" OD post
- 1¾" pulley sheave and set screws included

3 Year Limited Warranty

CAP-35	Green	\$25 EA	3 lbs
---------------	-------	---------	-------



See page 124 for the Easy Play Game Standard that can be used for Tennis or Pickleball

RolDri® Sponge Roller

- 36" wide seamless tennis court roller
- Durable polyvinyl alcohol construction
- Non-deteriorating foam molded directly to roller core for seamless fit to ensure rapid streak free drying
- 1 sponge included with roller
Call for freight quote.

1 Year Limited Warranty

TCSR	Roller	\$97 EA	7 lbs
TCSR-RR	Replacement Sponge	\$53 EA	3 lbs



Center Strap

- 2" adjustable nylon webbing
- Double snap hook

Center Anchor

- Stainless steel drive pin for easy snap assembly

* Limited Warranties

CS-1	Strap	\$13 EA	2 lbs
A-2	Anchor	\$19 EA	2 lbs



* Strap: 1 Year Limited Warranty, Anchor: 3 Year Limited Warranty

Courtside Benches

Portable 5' aluminum benches for courtside viewing.

- Durable and rust-resistant
- Single or double seat plank models
- Floor protection kit (PSS-4FT) for indoor use sold separately
Specify plank and leg colors when ordering.

3 Year Limited Warranty

PB40PC	Powdercoat, Single Plank w/Back	\$310 EA	50 lbs
PB40	Natural, Single Plank w/Back	\$279 EA	50 lbs
DPB50PC	Powdercoat, Double Plank	\$399 EA	55 lbs
DPB50	Natural, Double Plank	\$339 EA	55 lbs



Wind Screens

See page 78 for details about these products.

1 Year Limited Warranty

TWS-6	Classic Wind Screen	6' Height	\$0.82 SQ FT
TWS-9	Classic Wind Screen	9' Height	\$0.94 SQ FT
WSCRN-6	Armor Mesh Wind Screen	6' Height	\$1.07 SQ FT
WSCRN-9	Armor Mesh Wind Screen	9' Height	\$1.10 SQ FT





Tournament Tennis Net



- 3mm braided black polyethylene net
- Top 7 rows double meshed
- Multi-stitched heavy-duty 51 oz. vinyl headband
- 6mm vinyl coated steel cable
- Side pockets with dowels, tapered net bottom and includes center strap
- 42'L x 42"H

1 Year Limited Warranty

TTN-3 \$216 EA 25 lbs



Collegiate Tennis Net

- 3mm twisted black polyethylene net
- Multi-stitched heavy-duty 51 oz. vinyl headband
- 6mm vinyl coated steel cable
- Synthetic taped sides, tapered net bottom and includes center strap
- 42'L x 42"H

1 Year Limited Warranty

TPL-5 \$188 EA 15 lbs



Country Club Tennis Net

- 3.5mm braided black polyethylene net
- Top 7 rows double meshed
- 51 oz. reinforced vinyl headband
- Heavy-duty vinyl coated side and bottom tapes
- Side pockets with dowels
- Nylon webbing center strap included
- 42'L x 42"H

1 Year Limited Warranty

CCPTN42 \$200 EA 19 lbs



Economy Tennis Net

- Lightweight and weather-resistant
- 2mm knotless nylon net with 1½" sq. mesh
- 2" vinyl headband with ¼" dia. nylon cord cable
- Taped side and bottom edges
- 42'L x 42"H

1 Year Limited Warranty

TDP-42 \$155 EA 10 lbs

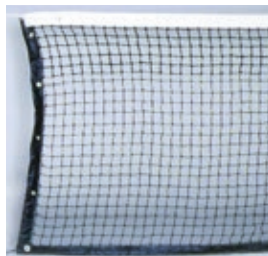

Indoor Tennis Net

- 36'L x 42"H
- Compatible with standard volleyball sleeve spacing

1 Year Limited Warranty

TPV-13 \$195 EA 14 lbs



Pickleball Net

- 2.5mm twisted polyethylene, 1¾" square black mesh
- Double mesh over top 5 rows
- Top headband is 2½" white woven polyester, 2½" PVC side fabric and ½" fiberglass dowel rods
- Top cord: 4mm vinyl coated steel cable
- Indoor/outdoor use
- 21'L x 32"H

1 Year Limited Warranty

PT-21N \$162 EA 12 lbs

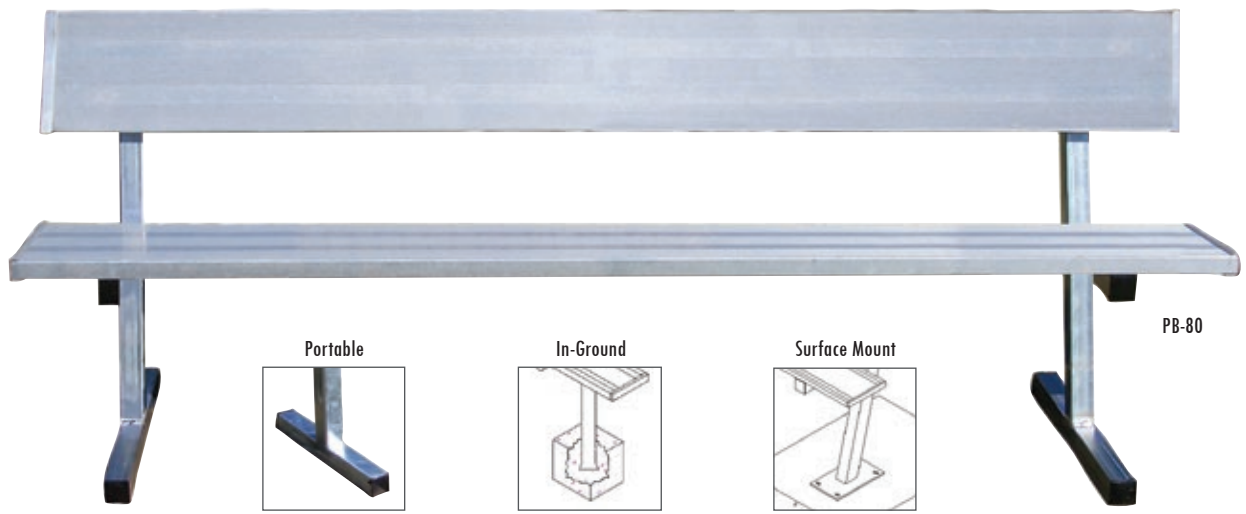

PB-80

Player Bench

Sturdy rust-resistant aluminum bench for athletic fields, public parks, and sport complexes.

- 10" wide non-skid seat planks
 - Heavy-duty rust-resistant steel legs
 - Portable, in-ground, or surface mount installation
 - Floor protection kit (PSS-4FT) for indoor use sold separately
- Specify plank and leg colors when ordering powder coat option.*



PB-75PC

3 Year Limited Warranty



	Length	Weight	Natural Finish			Price	Powder Coat			Price
			Portable	In-Ground	Surface		Portable	In-Ground	Surface	
w/ Seat Back	7½'	60 lbs	PB-80	PB-80PI	PB-80SM	\$350 EA	PB-80PC	PB-80PIPC	PB-80SMPC	\$440 EA
	15'	100 lbs	PB-20	PB-20PI	PB-20SM	\$545 EA	PB-20PC	PB-20PIPC	PB-20SMPC	\$663 EA
	21'	135 lbs	PB-10	PB-10PI	PB-10SM	\$690 EA	PB-10PC	PB-10PIPC	PB-10SMPC	\$950 EA
	27'	175 lbs	PB-90	PB-90PI	PB-90SM	\$808 EA	PB-90PC	PB-90PIPC	PB-90SMPC	\$970 EA
w/o Seat Back	7½'	33 lbs	PB-75	PB-75PI	PB-75SM	\$248 EA	PB-75PC	PB-75PIPC	PB-75SMPC	\$305 EA
	15'	57 lbs	PB-15	PB-15PI	PB-15SM	\$330 EA	PB-15PC	PB-15PIPC	PB-15SMPC	\$445 EA
	21'	79 lbs	PB-5	PB-5PI	PB-5SM	\$460 EA	PB-5PC	PB-5PIPC	PB-5SMPC	\$525 EA
	27'	101 lbs	PB-95	PB-95PI	PB-95SM	\$570 EA	PB-95PC	PB-95PIPC	PB-95SMPC	\$665 EA

169 Possible Color Combinations



Protect Indoor Surfaces



Floor Protection Kit

- Prevents floor marking
- 4 rubber feet and self-threading screws included

3 Year Limited Warranty

PSS-4FT

\$32 KIT

2 lbs



DPB50PC

Courtside Benches

Portable 5' aluminum benches for courtside viewing.

- Durable and rust-resistant
 - Single or double seat plank models
 - Floor protection kit (PSS-4FT) for indoor use sold separately
- Specify plank and leg colors when ordering powder coat option.*

3 Year Limited Warranty

PB40	Natural - w/ Back	\$279 EA	50 lbs
PB40PC	Powder coat -w/ Back	\$310 EA	50 lbs
DPB50	Natural	\$339 EA	55 lbs
DPB50PC	Powder coat	\$399 EA	55 lbs



PBS-20

Player Bench with Shelf

Durable rust-resistant aluminum bench with equipment shelf.

- 20" wide non-skid shelf for helmets, gloves, and other items
 - Non-skid seat planks and rust-resistant steel legs
- Specify plank and leg colors when ordering powder coat option.*

3 Year Limited Warranty



Length	Weight	Natural Finish	Price	Powder Coat	Price
7½'	95 lbs	PBS-80	\$630 EA	PBS-80PC	\$640 EA
15'	130 lbs	PBS-20	\$900 EA	PBS-20PC	\$1,060 EA
21'	185 lbs	PBS-10	\$1,190 EA	PBS-10PC	\$1,460 EA
27'	200 lbs	PBS-90	\$1,889 EA	PBS-90PC	\$2,299 EA



ST75PC

Scorer Table with Bench

Heavy-duty and rust-resistant. Ideal for any outdoor sport.

- 10" wide non-skid seat planks and rust-resistant steel legs
- Tabletop - 7½"L x 19"W

Specify plank and leg colors when ordering powder coat option.

3 Year Limited Warranty



Length	Weight	Natural Finish	Price	Powder Coat	Price
7½'	90 lbs	ST75	\$575 EA	ST75PC	\$691 EA

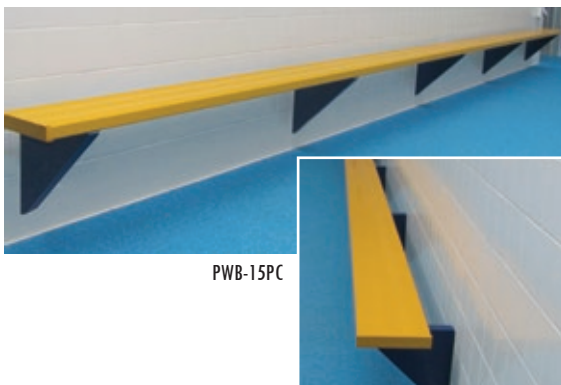

PBW-15PC

Wall-Mounted Player Bench

Rust-resistant aluminum bench ideal for locker rooms, aquatic centers, and outdoor applications.

- 10" wide non-skid seat planks
- Corrosion-resistant understructure

Understructure mounts to wall with stainless steel hardware (provided by local installer). Specify plank and understructure colors when ordering.

Length	Weight	Natural Finish	Price	Powder Coat	Price
7½'	20 lbs	PBW-75	\$340 EA	PBW-75PC	\$389 EA
15'	40 lbs	PBW-15	\$400 EA	PBW-15PC	\$470 EA
21'	60 lbs	PBW-5	\$525 EA	PBW-5PC	\$635 EA
27'	80 lbs	PBW-95	\$595 EA	PBW-95PC	\$744 EA

3 Year Limited Warranty





BLCH-4TRG



Tip & Roll Bleachers

Lightweight and stable aluminum bleachers tip for easy mobility and storage.

- 10" wide non-skid seat planks with sturdy understructure
- Single or double foot plank models
- Non-marking 4" swivel casters
- Foot pad protectors prevent floor marking

4 row bleacher does not exceed 30" in height. Guard rails may not be needed (check local codes). Specify plank and leg colors when ordering powder coat option.

3 Year Limited Warranty



BLCH-4TRG

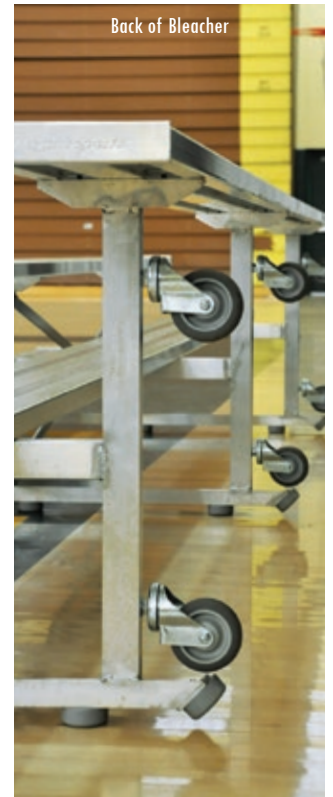

Back of Bleacher



BLDP-4TRGPC

	Rows	Length	Seats	Weight	Natural Finish	Price	Powder Coat	Price
Single Foot Plank Bleacher (Standard)	2	7½'	10	75 lbs	BLCH-275TRG	\$709 EA	BLCH-275TRGPC	\$829 EA
		15'	20	170 lbs	BLCH-2TRG	\$1,100 EA	BLCH-2TRGPC	\$1,295 EA
		21'	30	228 lbs	BLCH-221TRG	\$1,500 EA	BLCH-221TRGPC	\$1,600 EA
		27'	38	225 lbs	BLCH-227TRG	\$1,904 EA	BLCH-227TRGPC	\$2,150 EA
	3	7½'	15	118 lbs	BLCH-375TRG	\$1,000 EA	BLCH-375TRGPC	\$1,204 EA
		15'	30	210 lbs	BLCH-3TRG	\$1,443 EA	BLCH-3TRGPC	\$1,523 EA
		21'	42	310 lbs	BLCH-321TRG	\$1,880 EA	BLCH-321TRGPC	\$2,200 EA
		27'	54	330 lbs	BLCH-327TRG	\$2,460 EA	BLCH-327TRGPC	\$2,670 EA
	4	7½'	20	155 lbs	BLCH-475TRG	\$1,307 EA	BLCH-475TRGPC	\$1,537 EA
		15'	40	310 lbs	BLCH-4TRG	\$2,062 EA	BLCH-4TRGPC	\$2,297 EA
		21'	52	415 lbs	BLCH-421TRG	\$2,460 EA	BLCH-421TRGPC	\$2,720 EA
		27'	70	520 lbs	BLCH-427TRG	\$2,962 EA	BLCH-427TRGPC	\$3,507 EA
Double Foot Plank Bleacher (Preferred)	2	7½'	10	100 lbs	BLDP-275TRG	\$913 EA	BLDP-275TRGPC	\$1,010 EA
		15'	20	170 lbs	BLDP-2TRG	\$1,291 EA	BLDP-2TRGPC	\$1,440 EA
		21'	30	230 lbs	BLDP-221TRG	\$1,722 EA	BLDP-221TRGPC	\$1,970 EA
		27'	38	290 lbs	BLDP-227TRG	\$2,145 EA	BLDP-227TRGPC	\$2,428 EA
	3	7½'	15	150 lbs	BLDP-375TRG	\$1,107 EA	BLDP-375TRGPC	\$1,270 EA
		15'	30	150 lbs	BLDP-3TRG	\$1,693 EA	BLDP-3TRGPC	\$1,916 EA
		21'	42	360 lbs	BLDP-321TRG	\$2,193 EA	BLDP-321TRGPC	\$2,407 EA
		27'	54	455 lbs	BLDP-327TRG	\$2,828 EA	BLDP-327TRGPC	\$3,211 EA
	4	7½'	20	210 lbs	BLDP-475TRG	\$1,693 EA	BLDP-475TRGPC	\$1,888 EA
		15'	40	405 lbs	BLDP-4TRG	\$2,462 EA	BLDP-4TRGPC	\$2,659 EA
		21'	52	540 lbs	BLDP-421TRG	\$2,920 EA	BLDP-421TRGPC	\$3,344 EA
		27'	70	675 lbs	BLDP-427TRG	\$3,657 EA	BLDP-427TRGPC	\$4,045 EA

POWDER COAT COLORS





BLCH-4AL

All Aluminum Bleachers

Lightweight all aluminum bleachers are perfect for outdoor parks and fields.

- 10" wide non-skid seat planks with sturdy understructure
- Single or double foot plank models
- Indoor conversion kit (BLCHICK34) for indoor use sold separately

4 row bleacher does not exceed 30" in height. Guard rails may not be needed (check local codes). Specify plank and leg colors when ordering powder coat option.

3 Year Limited Warranty



BLDP-4AL



	Rows	Length	Seats	Weight	Natural Finish	Price	Powder Coat	Price
Single Foot Plank Bleacher (Standard)	3	15'	30	240 lbs	BLCH-3AL	\$1,423 EA	BLCH-3ALPC	\$1,526 EA
		21'	42	340 lbs	BLCH-321AL	\$1,694 EA	BLCH-321ALPC	\$1,895 EA
		27'	54	440 lbs	BLCH-327AL	\$2,353 EA	BLCH-327ALPC	\$2,568 EA
	4	15'	40	320 lbs	BLCH-4AL	\$1,870 EA	BLCH-4ALPC	\$1,855 EA
		21'	52	440 lbs	BLCH-421AL	\$2,400 EA	BLCH-421ALPC	\$2,459 EA
		27'	70	560 lbs	BLCH-427AL	\$2,827 EA	BLCH-427ALPC	\$3,213 EA
Double Foot Plank Bleacher (Preferred)	3	15'	30	290 lbs	BLDP-3AL	\$1,495 EA	BLDP-3ALPC	\$1,862 EA
		21'	42	415 lbs	BLDP-321AL	\$1,845 EA	BLDP-321ALPC	\$2,300 EA
		27'	54	540 lbs	BLDP-327AL	\$2,476 EA	BLDP-327ALPC	\$2,947 EA
	4	15'	40	395 lbs	BLDP-4AL	\$2,307 EA	BLDP-4ALPC	\$2,697 EA
		21'	52	550 lbs	BLDP-421AL	\$2,770 EA	BLDP-421ALPC	\$3,237 EA
		27'	70	705 lbs	BLDP-427AL	\$3,308 EA	BLDP-427ALPC	\$3,751 EA

169 Possible Color Combinations

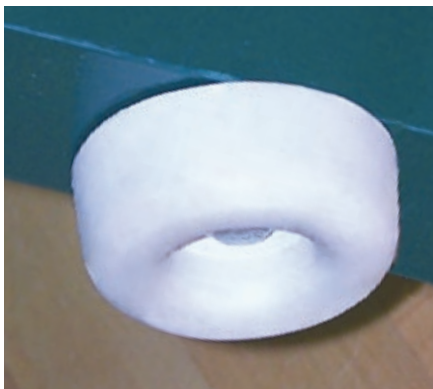

Indoor Conversion Kit

Protect floor surfaces with this outdoor to indoor bleacher conversion kit.

- 12 rubber pad protectors to prevent floor marking
- 7½' Bleacher - Requires 1 kit
- 15'/21' Bleacher - Requires 2 kits
- 27' Bleacher - Requires 3 kits

For 2, 3, and 4 row bleachers at lengths of 7½', 15', 21', and 27'.

3 Year Limited Warranty



BLCHICK34

\$56 SET 4 lbs



BTDP-3



BTBB-3PC

Back-to-Back Bleachers

Place between adjoining fields or indoor courts for spectator viewing from both sides of the bleacher.

- Lightweight 10" wide all aluminum seat planks and sturdy understructure
 - Single or double foot plank models
 - Indoor conversion kit (BLCHICK34) for indoor use sold separately
- Specify plank and leg colors when ordering powder coat option.*

3 Year Limited Warranty



	Rows	Length	Seats	Weight	Natural Finish	Price	Powder Coat	Price
Single Foot Plank Bleacher (Standard)	3	7½'	25	299 lbs	BTBB-375	\$2,087 EA	BTBB-375PC	\$2,276 EA
		15'	50	540 lbs	BTBB-3	\$2,576 EA	BTBB-3PC	\$2,764 EA
		21'	72	668 lbs	BTBB-321	\$3,725 EA	BTBB-321PC	\$3,725 EA
Double Foot Plank Bleacher (Preferred)	3	7½'	25	363 lbs	BTDP-375	\$2,331 EA	BTDP-375PC	\$2,664 EA
		15'	50	670 lbs	BTDP-3	\$2,864 EA	BTDP-3PC	\$3,219 EA
		21'	72	903 lbs	BTDP-321	\$3,553 EA	BTDP-321PC	\$3,940 EA

POWDER COAT COLORS

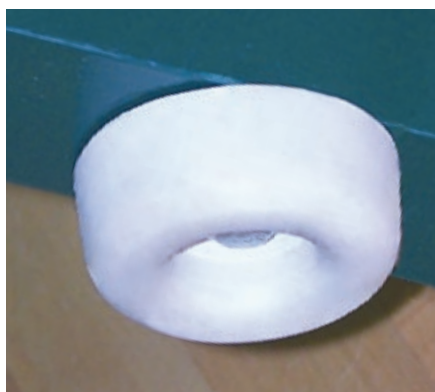

Indoor Conversion Kit

Protect floor surfaces with this outdoor to indoor bleacher conversion kit.

- 12 rubber pad protectors to prevent floor marking
- 7½' Bleacher - Requires 1 kit
- 15'/21' Bleacher - Requires 2 kits
- 27' Bleacher - Requires 3 kits

For 2, 3, and 4 row bleachers at lengths of 7½', 15', 21', and 27'.

3 Year Limited Warranty



BLCHICK34

\$56 SET 4 lbs



Standard Outdoor Bleacher

Heavy-duty outdoor bleacher with dual braces and rear stabilizing bar for increased strength.

- 10" wide aluminum non-skid seat planks
 - Galvanized steel understructure
- 4 row bleacher does not exceed 30" in height. Guard rails may not be needed (check local codes). Specify plank and leg colors when ordering powder coat option.

Rows	Length	Seats	Weight	Natural Finish	Price	Powder Coat	Price
3	15'	30	310 lbs	BLCH-3	\$1,397 EA	BLCH-3PC	\$1,450 EA
	21'	42	425 lbs	BLCH-321	\$1,770 EA	BLCH-321PC	\$2,040 EA
	27'	54	545 lbs	BLCH-327	\$2,211 EA	BLCH-327PC	\$2,504 EA
4	15'	40	390 lbs	BLCH-4	\$1,959 EA	BLCH-4PC	\$2,265 EA
	21'	52	520 lbs	BLCH-421	\$2,430 EA	BLCH-421PC	\$2,648 EA
	27'	70	650 lbs	BLCH-427	\$2,768 EA	BLCH-427PC	\$3,264 EA

3 Year Limited Warranty



Bleacher/Bench Plank Pad

Create comfortable bleacher seating for players and spectators.

- Straps buckle under plank for easy installation
- 7½' Bleacher - Requires 1 pad per row
- 15' Bleacher - Requires 2 pads per row
- 21' Bleacher - Requires 3 pads per row
- 7'L x 10"W x 1⅜"H

For bleachers at lengths of 7½', 15', and 21'. Specify pad color when ordering (Pink, Lime, Kelly Green, Light Blue, Royal Blue, Forest Green, Yellow, Orange, Dark Purple, Burgundy, Beige, Brown, White, Navy Blue, Red, Gray, Charcoal or Black). Call for freight quote (extended lead time may apply). Custom - non-returnable.

1 Year Limited Warranty



PLKPAD7

\$149 EA 5 lbs



Bleacher Transport Kit

Transport bleachers from field to field with ease.

- (2) 4"W x 12"H heavy-duty wheels
- Wheels and tongue easily attach and remove
- Fits any angle framed 2, 3, 4, or 5 row bleachers at lengths of 15', 21', and 27' - Vehicle Mounting Kit sold separately

3 Year Limited Warranty



BLCH-TOW4515	15'	\$864 KIT	120 lbs
BLCH-TOW4521	21' - 27'	\$971 KIT	150 lbs
BLCH-TMKIT	Vehicle Mounting Kit	\$254 KIT	60 lbs



BLCH-10GR



BLCH-521ASGRPC

Enclosed Bleacher

Heavy-duty enclosed bleacher with dual braces and rear stabilizing bar for increased strength.

- 10" wide aluminum non-skid seat planks
- Galvanized steel understructure
- Vertical guardrails or chain-link enclosure
- 5 or 10 row configuration
- Aisle option includes handrail in center of bleacher

Risers and double foot planks added to bleachers over 30" high for code and safety regulations. Specify plank, understructure, and guardrail colors when ordering powder coat option. Powder coat finish not available on chain-link enclosures or 10 row bleachers. Call for freight quote.

3 Year Limited Warranty



POWDER COAT COLORS



Enclosure	Rows	Length	Seats	Weight	Natural Finish	Price	Powder Coat	Price
Guard Rail	5	15'	50	1,172 lbs	BLCH-5GR	\$4,885 EA	BLCH-5GRPC	\$5,824 EA
Chain Link		15'	50	1,012 lbs	BLCH-5C	\$4,429 EA	N/A	N/A
Guard Rail		21'	62	1,452 lbs	BLCH-521GR	\$6,000 EA	BLCH-521GRPC	\$7,547 EA
Chain Link		21'	62	1,252 lbs	BLCH-521C	\$5,220 EA	N/A	N/A
Guard Rail w/Aisle		21'	58	1,500 lbs	BLCH-521ASGR	\$7,570 EA	BLCH-521ASGRPC	\$8,948 EA
Guard Rail		27'	80	1,732 lbs	BLCH-527GR	\$8,007 EA	BLCH-527GRPC	\$8,459 EA
Chain Link		27'	80	1,492 lbs	BLCH-527C	\$6,273 EA	N/A	N/A
Guard Rail	10	15'	100	2,500 lbs	BLCH-10GR	\$12,307 EA	N/A	N/A
Guard Rail		21'	140	2,700 lbs	BLCH-1021GR	\$15,285 EA	N/A	N/A
Guard Rail w/Aisle		21'	114	3,000 lbs	BLCH-1021ASGR	\$16,614 EA	N/A	N/A
Guard Rail		27'	170	3,464 lbs	BLCH-1027GR	\$18,774 EA	N/A	N/A
Guard Rail w/Aisle		27'	134	3,700 lbs	BLCH-1027ASGR	\$19,771 EA	N/A	N/A

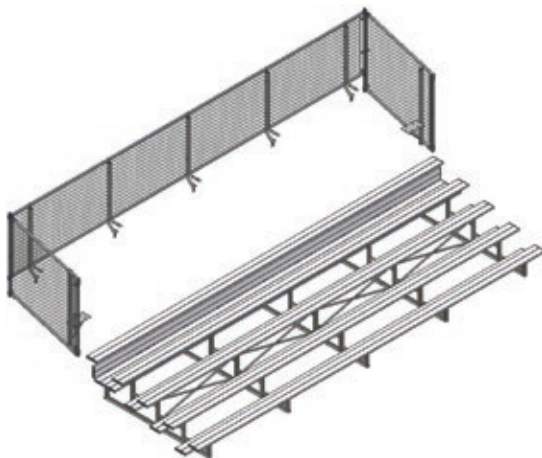

Universal Enclosure

Upgrade 5 row bleachers to comply with local safety codes.

- Enclose bleacher seating higher than 30" (fits most bleacher brands)
- Bolts to 5 row bleachers at lengths of 15', 21', and 27'
- Footboard, kickboard, attachment frame, and hardware kit included

3 Year Limited Warranty



BLCH5CUE15	15' - 5 Row	\$2,491 EA	250 lbs
BLCH5CUE21	21' - 5 Row	\$3,124 EA	275 lbs
BLCH5CUE27	27' - 5 Row	\$3,987 EA	300 lbs

Quick Index

Archery.....	126	Batting Cages.....	58-62	Goals, Box/Field.....	54-55	Nets.....	36
Backboards, Basketball.....	90-91	Batting Tunnels.....	66-69	Goal Cart.....	55	Rebounders.....	33, 38
Backstop Padding.....	64	Beach Volleyball System.....	19	Nets.....	56	Shelters.....	40-41
Badminton Posts/Net.....	6	Benches, Player.....	144-145	Training.....	57	Wheel Kits.....	28-29
Ball Storage.....	128-131	Bleachers.....	146-152	Netting, Protective		Storage & Transport	
Baseball/Softball.....	58-81	Bleachers, Enclosed.....	152	Custom.....	134	Ball Carts.....	128-131
Anchors.....	76	Bike Racks.....	127	Motorized.....	113	Baseball/Softball.....	76, 77
Backstops.....	63	Climbing Ropes/Ladders.....	119	Outdoor.....	133	Basketball.....	128-131
Backstop Padding.....	64	Combo Goals, Soccer/Football.....	42-43	Perimeter, Indoor.....	113	Bike Racks.....	127
Ball Cart/Hopper.....	77	Discus Cage.....	135	Portable.....	132	Football.....	50
Base Cart.....	76	Discus/Shotput Circles.....	136	Nets		Gymnasium.....	114
Bases.....	74	Divider Curtains.....	110-113	Baseball/Softball.....	59-62, 65, 72-73	Lacrosse.....	55
Batters Box Template.....	80	Dry Line Markers.....	82	Basketball.....	95	Soccer.....	26, 28, 29, 34, 38
Batting Cages/Accessories.....	58-62	Equipment Controllers.....	107	Field Hockey.....	53	Track & Field.....	136
Batting Tunnels, Indoor.....	68-69	Field Covers/Tarps.....	78	Football.....	51	Volleyball.....	11, 13, 15, 16
Batting Tunnels, Mounting Kits.....	69	Field Grooming.....	80-81	Lacrosse.....	56	Tennis.....	140-143
Batting Tunnels, Outdoor.....	66-67	Field Hockey.....	53	Pickleball.....	143	Accessories.....	142
Batting Tunnel Nets.....	65	Field Marking.....	82-83	Protective.....	113, 132-134	Benches.....	142
Fence Protection.....	79	Field Netting.....	132-134	Soccer.....	36	Nets.....	143
Field Covers/Tarps.....	78	Floor Hockey.....	126	Tennis.....	143	Posts.....	140
Field Grooming.....	80-81	Floor Sleeves		Volleyball.....	10	Wind Screen.....	142
Field Markers/Strippers.....	82-83	Badminton.....	6	Padding		Tetherball.....	125
Field Marking Systems.....	83	Tennis.....	14	Baseball/Softball.....	64, 79	Track & Field.....	135-139
Foul Poles.....	70-71	Pickleball.....	141	Basketball.....	96-97	Cages.....	135
Game Mounds.....	77	Volleyball.....	14	Bleachers.....	151	Circles.....	136
Home Plates.....	75	Football.....	44-52	Football.....	48	Crossbars.....	138, 139
Marking Dust.....	83	Accessories.....	47, 49	P.E.....	122, 123	High Jump Standards/Pits.....	139
Mound/Base Covers.....	78	Ball Stop System.....	46	Rugby.....	43	Hurdles.....	136
Paint, Field Marking.....	83	Chutes.....	51	Volleyball.....	8, 13	Pole Vault Standards/Pits.....	138
Pitcher Rubbers.....	75	Goal Posts.....	44-45	Wall Pads, Indoor.....	115-117	Sand Pit Forms.....	137
Pitching Machines.....	99	Goal Posts, H-Frame.....	43	Wall Pads, Outdoor.....	64	Starting Blocks.....	136
Pitching Mounds.....	77	Goal Posts, Overhead.....	46	Pickleball, Portable.....	141	Take Off/Toe Boards.....	136, 137
Protector Nets.....	72-73	Ground Sleeves.....	47	Pickleball Posts/Net.....	141, 143	Vault Boxes.....	138
Protector Screens.....	72-73	Kicking Cages.....	51	Pitcher Screens.....	72-73	Turf.....	64
Rail Padding.....	79	Padding.....	48	Player Benches.....	144-145	Volleyball.....	2-19
Storage Racks.....	77	Storage Racks.....	50	Portable Basketball Systems.....	102-103	Anchors.....	15
Turf.....	64	Training.....	52, 99	Post Pads, Basketball.....	97	Antenna.....	8
Wind Screen.....	78	Foul Poles.....	70-71	Post Pads, Football.....	48	Ball Carts.....	16
Basketball.....	84-98	Futsal Goals.....	30	Post Pads, Volleyball.....	13	Beach Volleyball System.....	19
Adjustable Systems.....	84	Game Standards.....	122-125	Protective Screens,		Floor Sleeves.....	14
Backboard Padding.....	96	Graphics, Custom.....	120	Baseball/Softball.....	72-73	Nets.....	10
Backboards.....	90-91	Ground Anchors		Rims.....	92-95	Outdoor Systems.....	18-19
Backboard Adapters.....	98, 121	Baseball.....	76	Rugby Goal/Padding.....	43	Overhead System.....	9
Backstop Height Adjusters.....	108	Soccer.....	35	Scoreboards.....	100-101	Padding.....	8, 13
Fixed Height Systems.....	85-86	Ground Sleeves		Scorer Tables.....	115, 145	Referee Stands.....	12
Goals/Rims.....	92-95	Baseball/Softball.....	71	Shelters.....	40-41, 49	Replacement Parts.....	16
Gooseneck Systems.....	87-88	Football.....	47	Shot/Discus Circles.....	136	Storage Carts.....	128-131
Hoop Rejuvenator Kits.....	86	Soccer.....	26, 27	Soccer.....	20-43	Storage Racks.....	11, 13, 15
Nets.....	95	Tennis.....	140, 141	Accessories.....	37, 39	Training.....	17, 99
Padding.....	96-97	Track & Field.....	135	Anchors.....	25, 34-35	Uprights/Systems.....	2-8
Portable Systems.....	102-103	Height Adjusters.....	108	Ball Stop System.....	23	Wall Pads.....	115-117
Storage Carts.....	128-131	Lineman Chutes.....	51	Combo Goals, Soccer/Football.....	42-43	Winches.....	106
Straight Post Systems.....	89	Lacrosse.....	54-57	Futsal Goals.....	30	Wind Screen.....	78
Wall-Mounted Backstops.....	104	Ball Stop Systems.....	57	Goals, Official/Club.....	20-29	Wrestling Mat Storage.....	114
Wall-Mounted Shooting Stations.....	105	Field ID Markers.....	57	Goals, Practice/Training.....	31-33		

Terms & Conditions

Contact your Local Jaypro Sports Representative or Jaypro Sports for detailed information on Terms & Conditions

Returns: Jaypro Sports will accept the authorized return of all standard products for any reason within 30 days of the ship date. SPECIAL ORDER/CUSTOM COLOR ITEMS ARE NOT RETURNABLE. Customers must obtain a return authorization number from Jaypro Sports after supplying the invoice number, item number, and reason for return. Customer is responsible for a 25% restocking fee and return freight charges.

Freight Damages & Discrepancies: Damages or shortages must be reported within 7 days of the delivery date. It is the responsibility of the customer to sign the delivery receipt as damaged or short. If Jaypro Sports is notified within this time frame, we will replace as needed and file the claim with the carrier.

Payment Terms: We accept checks, American Express, Discover, MasterCard, and Visa. Approved accounts are required to submit a purchase order and will be billed Net 30 from the invoice date. All past due accounts are subject to a 1.5% per month (18% per year) interest charge and collection costs. Any approved account choosing to pay by credit card after the invoice date may be subject to a 3% credit card processing fee.

Warranties: Limited Warranty: Jaypro warrants most of our products against defects in workmanship and material for three years from the date of shipment, unless otherwise noted in the catalog.

We reserve the right to correct typographical errors. Visit www.Jaypro.com for a full list of Terms & Conditions.



JAYPRO SPORTS IS
GOING GREEN

Use your mobile device to scan this code
and download our digital catalogs.



PRESORTED STD
U.S. Postage Paid
Bolingbrook, IL
Permit No. 648

Jaypro Sports LLC
976 Hartford Turnpike
Waterford, CT 06385

Contact your local Dealer
or Jaypro Sports at:

800-243-0533 (Call Toll Free)
800-988-3363 (24/7 Fax)
JAYPRO.COM (Online)

- Dealer Rated BEST in Customer Service
- Multi-Year Warranties
- Trusted for Decades



DESIGNED TO PERFORM.
MANUFACTURED TO LAST.

EXCEPTIONAL EQUIPMENT FOR EXCEPTIONAL FACILITIES

Jaypro Sports has been a leading authority for institutional sports equipment since 1953. A wealth of experience is engineered and manufactured into each piece of equipment supplied to the best projects in the industry.

www.Jaypro.com